

RADIO NEWS

MARCH
1941
25c
In Canada 30c

NSE

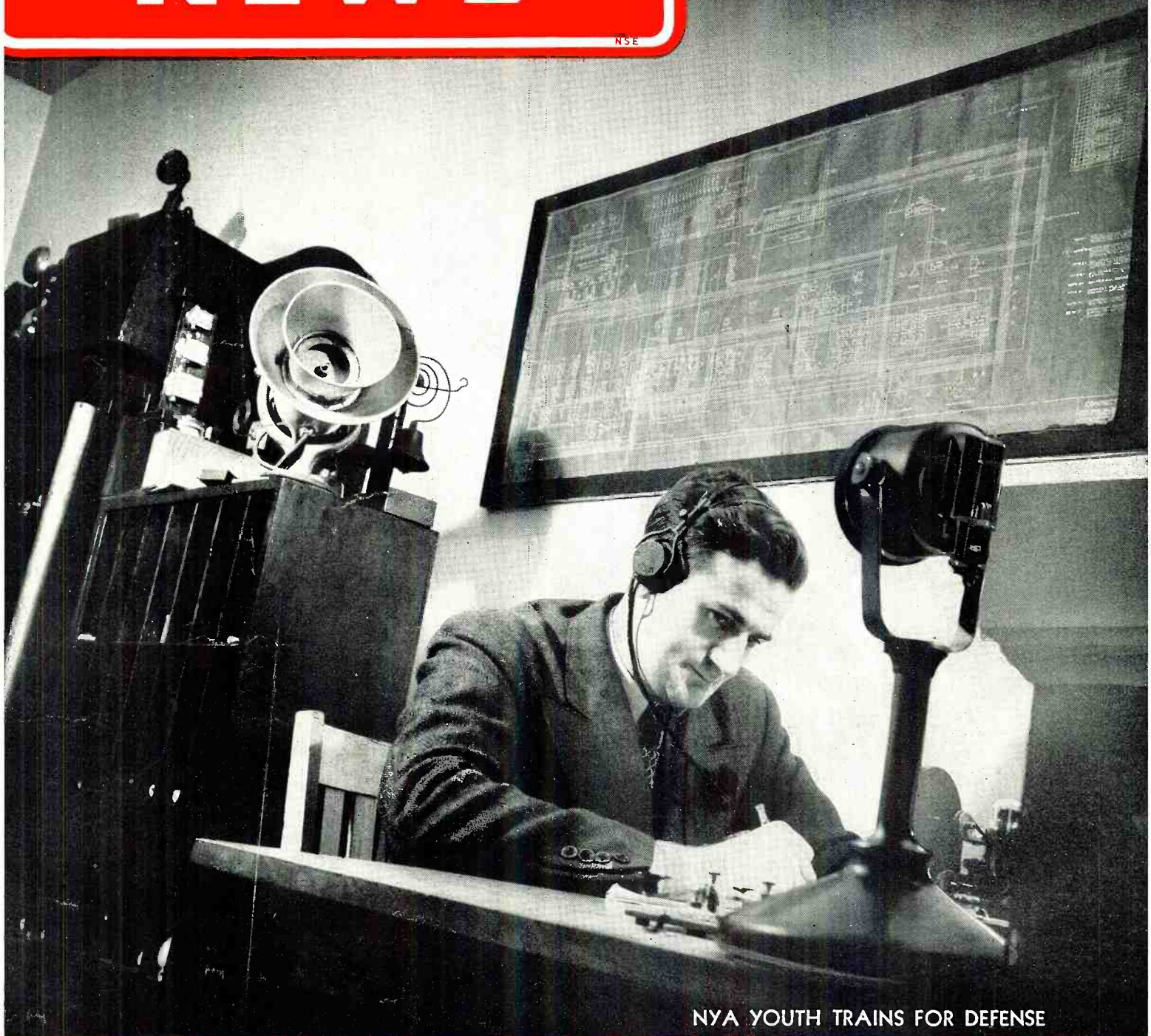

NYA YOUTH TRAINS FOR DEFENSE

FM vs AM: The Radio Battle of 1941

AMATEURS RESCUE AMARILLO * SOUND MIXER CIRCUITS

BUILD A PORTABLE PHONO-RADIO

Serviceman's Electronic Volt-Ohmmeter

IT'S HERE! IT'S FREE!

ORDER
from your
distributor
TODAY!

MALLORY
1941 Replacement VIBRATOR GUIDE
with "Radio in 1941 Cars"

More Than Ever... Insist on Mallory

The Only COMPLETE Vibrator Guide with Exclusive Data "Radio in 1941 Cars"

- Up-to-the-minute, completely accurate vibrator replacement chart for all makes and models of auto radios and battery operated home receivers.
- Complete cross-reference of Mallory Vibrators by make and model of receiver.
- Interference elimination, and auto radio installation in all 1941 cars. An exclusive Mallory feature.
- Vibrator connection charts.

P. R. MALLORY & CO., Inc., INDIANAPOLIS, INDIANA • Cable Address—PELMALLO

More
than ever
—INSIST ON

P. R. MALLORY & CO. Inc.
MALLORY
APPROVED
PRECISION PRODUCTS

VIBRATORS • VIBRAPACKS • CONDENSERS •
VOLUME CONTROLS • ROTARY SWITCHES •
SINGLE AND MULTIPLE PUSH BUTTON SWITCHES
• RESISTORS • RADIO HARDWARE

DAVEGA AMATEUR RADIO—63 CORTLANDT ST., N.Y., N.Y.
(DIVISION OF DAVEGA CITY RADIO—WORLD'S LARGEST RADIO DEALER)

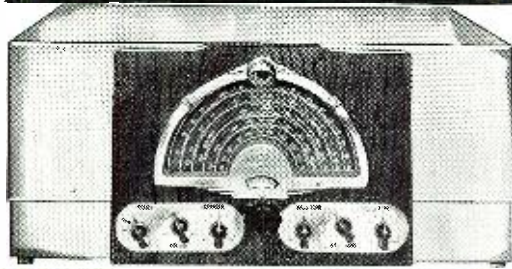

FINEST McMURDO CHASSIS EVER BUILT!

- Two R.F. Stages
- Variable Selectivity
- Giant Jensen 18" Speaker
- Finest Shielding
- 34 Watts Undistorted

Built to
Sell for
\$350.00

189⁵⁰

Complete including 18" Speaker made by Jensen

Several Demonstrator Models in New Condition, Special 149.50

A Really Wonderful Value!

- Ten independent ranges—Six general, four amateur band-spread
- Full vision velvet vernier dial—ratio 30 to 1
- Sensitivity—better than one microvolt
- Signal to noise ratio better than 30 db. at ten meters
- Stability—3 parts in 100,000 with a 20 volt line fluctuation
- Wide range crystal filter with rejection ratios as high as 10,000 to 1
- Low drift temperature compensation
- Series valve noise limiter
- Crystal clear tone with 8 watts undistorted output
- Amateur net price with speaker in cabinet—\$147.50



Federal Recorder Model P 12

Professional 12" recorder, 15 watt audio public address, 25.00 mike and stand. Perfect recordings.

Demonstrators (Like New)

List Price over \$200.00 **69.50**

Sargent WAC44

Regular Price \$139.50 **94.50**

Two stages, pre-selection, frequency monitor, permanent alignment from panel.

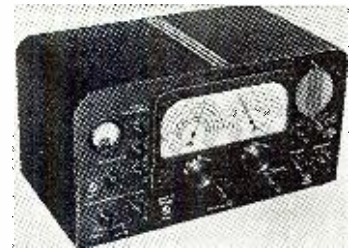

HALLICRAFTER SUPER SKY RIDER

- 6 BANDS • 15 TUBES
- VARIABLE SELECTIVITY
- 2 R.F. STAGES
- HI-FI-AUDIO SYSTEM FOR FINE TONE

159.50

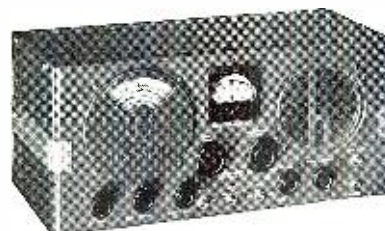

Hallicrafter S.20R

R.F. stage, 2 I. F. stages, 9 tubes, noise limiter, bandspread.

49.50

Hallicrafter SX23

THE SET THAT HAS EVERYTHING. WRITE FOR OUR SPECIAL PRICE.



USED RADIOS—ALL EXCELLENT BUYS

One or Two of a Kind—Place Your Order Early

National-NC100X	59.00	Hammerlund Pro	19.95
Hallicrafter S9	18.95	McMurdo 5C	19.95
Hallicrafter S11	24.50	National B-7	10.00
Hallicrafter 16	59.00	Howard 438X	39.00
Hallicrafter 17	74.00	Howard 460	49.50
Hammerlund HQ120	96.00	Howard 430	19.95
ACR111	69.50		

AMATEUR DIVISION, 63 Cortlandt St., N. Y., N. Y.
World's Largest Radio Dealer

DAVEGA



BY THE EDITOR

IT is fortunate that as a technical magazine we are not concerned with the current ASCAP-BMI fight being aired—and we do mean, aired—over the broadcast stations. We hope that justice will be done to both sides, and that the scrap will soon be over for the ultimate benefit of John Q. Public. One thing has interested us, though, and that is the tremendous increase in the sale of phono-radios which has taken place since the first of the year. This reversal to recorded music instead of radio broadcasted tunes has been a landfall to the serviceman who has been busy converting radios to phono-combinations and also selling straight electric phono-amplifiers. It is usually an ill wind that blows someone some good!

THAT FM vs AM fight reported herein elsewhere is a "sleeper." We first smelled a story when our Washington Correspondent let us know of the proposed bill which was to be introduced into the Senate. Since then he has been legging it all over the Capitol City running down leads, many of which proved to run into blank walls. But there is a real behind-the-scenes story replete with drama, suspense, intrigue and politics in that resolution S.R.20, which will probably never entirely come to light. What we have done is to skim the surface and report on so much as we could find out. That was little enough; but if they ever really get going on a real investigation into radio in all of its phases, the fur will fly. Yessir, brother, the fur will fly!

OUR laboratory is richer by the acquisition of one W9JU, who has joined our staff permanently. Ray Frank, who sports the call, has been active in radio since 1919 when he got his ticket. Ray's first call was 9ANX, issued in '19. He also had 9DRU in about 1923. He comes to R.N. with a background obtained in the service of *Western Electric Co.*; is active in the *Hamfester's Radio Club* of Chicago, and a charter member of the *Prairie Dogs*, that well-known Field Day Group. At present W9JU is devoting his entire time at home dabbling with FM, and at the office in engineering the mechanical end of the Super Superhet, which starts next month.

IN a rash moment we told John Rider to go ahead with a story on the future of the electron and the radioman. We could not have been thinking very hard, or else we would have realized that such a topic could not be covered in a book many times the size of this one. But the subject fascinated us, and more and more we

(Continued on page 42)



Trade-Mark Registered

Including Articles on POPULAR TELEVISION

The Magazine for the radio amateur experimenter, serviceman & dealer
VOL. 25, NO. 3

Contents for March, 1941

FEATURES

- Amateurs Rescue Amarillo**.....Sanky Trimble **6**
Once more the amateurs justify their existence.
- The Radio Battle of 1941; FM vs AM**.....Alfred Toombs **7**
The inside story of the coming battle for an empire.
- Electrons and the Radio Man's Future**.....
.....John F. Rider & Karl A. Kopetzky **8**
How the radioman's future will be affected by the minute electron.
- Build Your Own Portable Phono-Radio**.....Oliver Read, W9ETI **10**
Constructing a unit comparable with the manufactured product.
- Add an Expander for Quality**.....L. M. Dezettel **13**
This unit, plus your radio receiver, equals fine reproduction.
- A Ham Builds His Own Communication Receiver**.....
.....Bill Davis, W5GHU **14**
For the amateur with small pocketbook—big ideas.
- Homebuilt Electronic Volt-Ohmmeter**.....Norman E. Nelson **18**
A useful addition to any service-shop or ham-shack.
- The "Prairie Dog" Special Transmitter**...Raymond Frank, W9JU **21**
A well-tested versatile QRR and Field Day unit.
- Communication & Electronic Maintenance**.....W. H. Bohlke **24**
Completing the service bench with the audio oscillator and oscillograph.
- Remote Radio Controller**.....Allen D. Rickert, W3EQX **28**
A lazy man's transmitter control.
- Sound Mixer Circuits**.....Clark E. Jackson **38**
A discussion of the best mixer input circuits for P.A. use.
- NEW FEATURE:**
Police Radio.....William T. Peterson **37**
A monthly column devoted to this all-important subject.

Cover Picture: One of the many NYA students hard at work learning the code. An official NYA picture.

DEPARTMENTS

- | | | |
|--------------------------------------|---------------------------------------|---------------------------------------|
| Book Review..... 40 | QRD?..... 35 | Serviceman's Experi-
ences..... 20 |
| What's New in Radio.. 26 | Bench Notes..... 36 | Serviceman's Cases... 66 |
| Radio Physics Course.. 42 | Manufacturer's Literature 40 | The Video Reporter... 41 |
| Hamchat'er..... 32 | Aviation Radio..... 23 | Mikes-Heads-Pickups... 29 |
| Servicemen's Legal
Advice..... 31 | Washington Communi-
cation..... 21 | Ringin' the Bell..... 30 |

Copyright 1941,
ZIFF-DAVIS PUBLISHING COMPANY
Member of the Audit Bureau of Circulations

RADIO NEWS is published monthly by the Ziff-Davis Publishing Company at 608 S. Dearborn St., Chicago, Ill., William B. Ziff, Publisher; B. G. Davis, Editor; J. Fred Henry, Business Manager; Karl A. Kopetzky, W9QEA, Managing Editor; Oliver Read, W9ETI, Technical Editor; Raymond Frank, W9JU, Laboratory Technician; Herman K. Bollin, Art Director; S. L. Cahn, Advertising Manager. New York Office, 381 Fourth Ave. Subscription \$2.50 per year, single copies, 25 cents; foreign postage \$1.00 per year additional, Canada 50c additional. Subscribers should allow at least 2 weeks for change of address. All communications about subscriptions should be addressed to: Director of Circulation, 608 S. Dearborn St., Chicago, Ill. Entered as second class matter March 9, 1938, at the Post Office, Chicago, Illinois, under the Act of March 3, 1879. Contributors should retain a copy of contributions. All submitted material must contain return postage. Contributions will be handled with reasonable care, but this magazine assumes no responsibility for their safety. Accepted material is subject to whatever adaptations, and revisions, including "by-line" changes, necessary to meet requirements. Payment will be made at our current rates upon acceptance and, unless otherwise specified by contributor, all photographs and drawings will be considered as constituting a part of the manuscript in making payment.

3 BIG VALUES *from* HARVEY!

On Our Special Time Payments and Liberal Trades . . . Cameras Accepted in Trade On Any Ham Receiver



Model SX-28 Hallicrafters new 1931 Super Skyrider delivers praiseworthy results no matter what the operating circumstance. This 15-Tube, 6-band communications receiver has a frequency range of 550 kc. to 42 mc. Two stage preselection. Calibrated band-spread in-

ertia controlled. 80, 40, 20, 10 meter amateur bands calibrated. 5 step wide range variable selectivity. Band pass audio filter. Improved signal to image and noise ratio. Model SX-28 with crystal and tubes, \$159.50.

MODEL S-31. Hallicrafters High Fidelity Tuner for frequency modulation and amplitude modulated broadcast reception. The No. 1 band covers all frequencies used by amplitude modulated broadcast stations. The No. 2 band covers frequencies used by high fidelity frequency modulated broadcast stations. Model S-31 tuner combines both circuits and changes from FM to AM with the bandswitch. 8 Tubes. Frequency range band one: 540 to 1650 kc., band two: 40 to 51 mc. Model S-31 tuner, \$69.50.



Model S-31A. Hallicrafters High fidelity, 25 watt amplifier, (To appreciate the full capabilities of the S-31 FM/AM tuner a high fidelity audio system should be incorporated. A high fidelity audio system consists of not only a high fidelity amplifier but also a high fidelity speaker system). Model S-31A amplifier complete with cabinet and tubes, \$49.50.



W21J1 W2LJA
W2KWY

OUR *Best* VALUE IS OUR RECORD OF LOYAL SERVICE

HARVEY

Radio Company of New York

103 WEST 43rd STREET • NEW YORK, N. Y.

CABLE ADDRESS
"HARADIO"

Amateurs RESCUE AMARILLO



by *Sanky Trimble*

Clovis, New Mexico

Once more the populace called on the radio amateur, and as usual that grand bunch of men came through. Amarillo owes a lot to the few hams who rescued it!

It is no longer news that the radio amateurs of our country have come to the rescue of a community struck by a storm, a flood, or some catastrophe. The continual re-occurrence of this type of emergency work by the hams who have never failed their government, is what argues mightily against a war-emergency radio amateurs' blackout. As is usual in this kind of report, there may be some hams whose names have been omitted. That is not done intentionally, but it is virtually impossible to obtain the names of ALL who participated. We apologize to any ham who falls in this latter class.—The Editors.

✓ **RIPPLED** more than temporarily by the worst ice storm in the history of West Texas, Amarillo—a busy little metropolis set high on the *Llano Estacado* or the Panhandle

—today owes most of its progress in digging out from under the debris to a group of amateur radio operators, the “hams.”

It was on the weekend of November 23 of last year that a slow drizzle and steady sleet set in over a wide area on the Panhandle, including regions bordering into Colorado and New Mexico. Sunday, November 24, the sleet and rain froze into formidable proportions of ice and under the strain of the frozen white tons, thousands of telephone & telegraph poles, trees and shrubs snapped. Communication lines for at least a hundred miles in each direction were sent crashing to the sleet-covered ground. Power failed, communications went out, and Amarillo, as well as other smaller Texas cities and towns in the region was completely isolated from the rest of the world.

This was the scene which greeted a startled and crippled city next day.

With continuance of freezing weather, the situation grew worse. Practically without power, Amarillo could no longer man the city water pumps and thousands of residences went on forced water rations. Small fires caused by short circuiting high tension wires blazed in various parts of the city. Motoring was at a standstill because of fallen trees, poles and debris block-

(Continued on page 52)



Poles wrecked cars; stopped traffic.

W5DER (right) and C. C. Conover.



Hamop N. C. Settle, who helped.

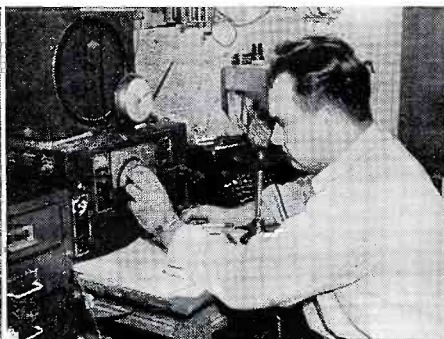

Two hams in the *Globe-News* office.



77TH CONGRESS
1ST SESSION

S. RES. 20

IN THE SENATE OF THE UNITED STATES

JANUARY 6, 1941

Mr. TOBEY submitted the following resolution; which was referred to the Committee on Interstate Commerce

RESOLUTION

- 1 *Resolved*, That the Committee on Interstate Commerce,
- 2 or any duly authorized subcommittee thereof, is authorized
- 3 and directed to make a full and complete investigation with

The Radio Battle of 1941

FM vs AM

by ALFRED TOOMBS

Special Washington Correspondent for RADIO NEWS.

Unknown to many, there is a terrific battle going on for the mastery of the ether. It involves millions of dollars and some real fighters.

A VAST and mighty empire is at stake in the battle which has taken shape behind the scenes in Washington. It is the empire of the great chain broadcasting systems—NBC, Columbia and Mutual; of the vast manufacturing plants of RCA and others; of the great leased wire system of the A. T. & T.

This empire is challenged and its immediate future is threatened by an aggressive, upstart band known as the FM Broadcasters, Inc. The Federal Communications Commission has given the FM Broadcasters the nod and has signed on with them as secret ally. The empire is gathering its forces and from the White House to Capitol Hill the opening skirmishes are being fought.

This is the hottest story in radio today and, though the sounds of battle have not yet reached the public, it will not be long before the implications become something more than matters of academic interest to almost everyone.

Relatively few people know, or care,

much about Frequency Modulation now. Those who do know of it, think of FM merely as a method of clear-toned broadcasting, which has certain virtues which the standard AM has not. Almost no one realizes that the success of FM would mean that the whole face of American broadcasting would be changed. In the process, the strangle-hold which the big networks and high-powered AM stations have on the broadcasting business would be broken—or perhaps the chains would be lost in the struggle. Certain big manufacturing plants might find themselves fighting an uphill battle. The number of broadcasting stations might be increased rapidly and the whole employment picture, in the manufacturing and broadcasting fields, might be changed radically.

The FCC, the AM broadcasters and the FM broadcasters have taken all these things into consideration. They form the basis for the struggle which is in the making in the shadowy half-world where issues are fought out in Washington. There are billions at

stake and there are powerful interests and determined men to contend for them.

The potent chairman of the FCC, James Lawrence Fly, has lined his big-business-busting compatriots on the Commission up on the side of FM. The Commission is going down the line for the new system. The FM Broadcasters have gathered together a group of comparatively unknown, but successful, radio men. They have the resources in cash and equipment to carry on broadcasting. They have the manufacturing facilities now to turn out the sets.

The AM broadcasters, sitting on a keg of dynamite which they can't afford to abandon to the enemy, are plotting a careful strategy to meet the attack. They are in an exposed position and their moves must be adroit.

The story has its beginnings back in 1933, when Major Edwin H. Armstrong, Columbia University professor of electrical engineering who had a string of radio patents to his name,

(Continued on page 43)

ELECTRONS and the

by JOHN F. RIDER & KARL A. KOPETZKY

No one knew when the Hertzian Wave was first discovered, that we were on the threshold of a new era, a period of electrons, whose daily applications has increased a thousandfold. The radioman's future is with the electrons.



Latest electron discovery, the electronic microscope. Uses cathode rays.

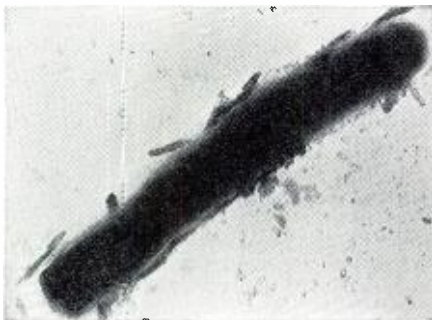

Bovine T. B. bacillus 22,700 times enlarged by the electron microscope.

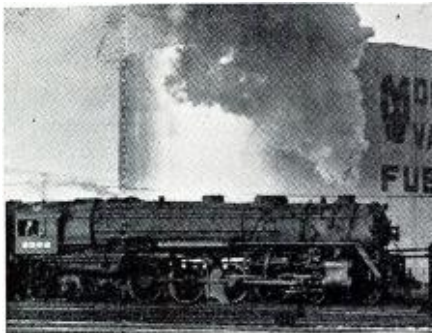

Trains may some day be completely controlled by the lowly electron.

A GREAT philosopher has rightly said that the development of science has kept step with the development of the human being. When man was but a shade removed from the animal world from which he arose, his needs were negligible—a club to defend himself, a pelt to cover himself,—and food to continue living. As life for the human became more complex, his needs increased, and the world witnessed the advent of writing, cooking, building, and all the things that have continued to be developed as the human race became older, and hence, advanced.

Castor oil, the little boy's plague, was well-known years before the birth of Christ, but one may state with comparative certainty that its use as a lubricant for airplane engines was not thought of at the time that Moses was being rescued from the bullrushes. The property of lubricating airplane engines has *always* been a use to which castor oil could be put, but its application for that purpose had to await the invention of the airplane, and thereby the need of the human race for airplanes, so that they, in turn, would be invented.

So it has been with radio and electrons. When the *Hertzian Wave* was discovered, its use for communications was not thought of, nor did Franklin, dangling a key on a kite string, think of electricity as a stream of electrons. But as science advances, and pushes back the curtain of ignorance, the knowledge that all electricity is but a function of electronics, that radio is a division of the field of electronics, and most to the point, that electronics—that is, the application of electrons—would become universal, becomes more and more a certainty. Hardly a day goes by that some new use for elec-

trons is not discovered. Actually, of course, electrons themselves are not used, only the magnificent work which can be done by and with them. And all this, without anyone ever having seen an electron, nor ever having seen an electron come into being. One of our surest axioms is, that there is on this globe everything that has *ever* been there, and that nothing has been destroyed,—only changed, or converted, as the scientist says. Then it is safe to state that we have always had electrons with us, and it is only now, when human advancement has arrived at the stage that it can encompass, when it can use, when it needs electrons, that their almost universal uses are coming to light.

What has all this to do with the radioman? Just this. Aside from the professors, the technicians, the scientists, who of all persons has the best knowledge of electrons? The *radioman*. Because he has made continual use of these particles of power, because he has been a part of the development of the electronic art in one of its phases, because he has watched the development of the electronic art from almost its inception, none but the radioman, and his first cousin, the radio serviceman, has a general insight into electronics. So it can be said with considerable truth, that the radioman and the electrons are inseparably tied up together, and that the future of the radioman lies in the further development of the electronic art.

What does this future envisage? We have seen that telegraphy has finally reached a saturation point; that telegraphers familiar with wire communications are becoming a "lost" profession; that those whose sphere of knowledge was limited to the handling of a telegraph key, have found it more and



Using electrons to write and to draw has become quite commonplace. We know the system as "facsimile." Banking is being attempted by facsimile.

Radioman's Future

more difficult to "make a living" with what they knew. So it will finally be with the radioman and the serviceman. Unless—and here lies the crux of the matter—he keeps step not only with the electronic art as far as it has advanced this year, but prepares himself for the future—a future based on electronics. This means that he must be ready to grasp the theory as well as the application of the laws and physics appertaining to electronics, and that his outlook on the subject matter must at once be flexible and broad. In order to try to appreciate what the future in electronics may bring, it might be well to enumerate and discuss generally the steps which have been made in the art to date. Completely to cover the subject, if only to number *all* the applications of the work which electrons do, would take a volume several thousand times larger than this magazine, so only a slight small section can be touched upon.

But no matter how deft the touch, no matter how little is said, the future of the radioman, and the serviceman is one with electronics. If a small part of that field will serve to show the magnitude of the uses to which electronics can be applied, and the radioman will be guided by the obvious directions which the trend indicates, then he will see where he must spend his greatest effort, his most amount of study, that he, like the telegrapher mentioned before, so as not to be left in a "lost" profession.

The Electron Microscope

The electron microscope is the outcome of the cathode-ray tube. But who, back in 1935 when the cathode-ray oscillograph was first exploited for the radio servicing industry, would have ventured an opinion that the conventional microscope using light as the means of seeing objects, in use since about 1600, or for more than 340 years, would be made obsolete by a development founded upon a particle of negative electricity? When we say that the electron microscope makes the present type of unit obsolete, we are speaking about future developments which will enable the production of such electron operated units available at a cost comparable to modern-day

light-microscopes. At present the electron ray microscope is entirely too expensive for general application, but if what has been accomplished by quantity production in other branches of the radio industry is an indication, we doubt if anyone would venture the statement that cost of such "electron scopes" always will be prohibitive.

Considering the tremendous increase in resolution and magnification possible with the electron ray unit, the electron microscope makes visible viruses which cannot be seen with the best of optical microscopes. Basic magnification in the everyday microscope with normal light is limited to about 1300 or 1400 diameters. With ultra-violet light, it is about 3000 times. In the electron ray unit, they speak of magnification up to 30,000 times; with further photographic magnification up to 100,000 times.

At present, in the medical field, electronic apparatus takes the form of X-ray apparatus, electro-cardiographs, high frequency knives, artificial fever producing apparatus and the like. Now there is brought into being an electron operated device which has untold possibilities, for if it makes visible bacteria and other forms of matter which have hitherto been invisible to the doctor in his tireless search for the cause of disease, a tremendous stride forward has been made.

But is this device suitable only for medicine? Definitely not. The normal microscope of today does not find its application only in medicine. Every branch of science and industry where individuals are concerned with the structure of matter and what happens to the many forms of matter under different conditions, have occasion to use such electron operated units. We don't mean to forecast how soon the present day electron microscope will get into industry, or when, as a result of quantity production, or simplification for various fields, the prices will be lowered so as to embrace a much wider field of acceptance. Be that as it may, the fact nevertheless remains that electronics has stepped into a field where it was totally absent without even a remote association. All of a sudden—out of the clear blue

(Continued on page 46)

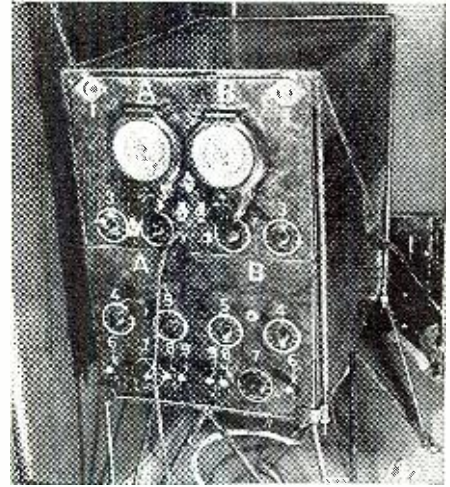

An electron-controlled air-track to guide planes is a new discovery.

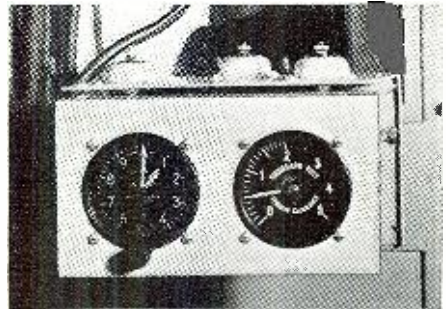

The absolute altimeter is a development of u.h.f. electron movements.

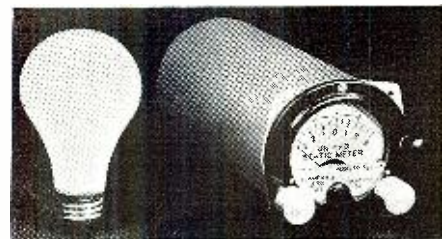

This static indicator depends on the electron for its functioning.

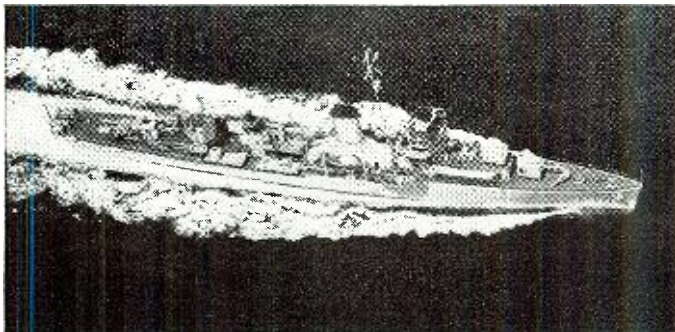

Remotely steered battleships are not new. But we will see those which can shoot and maneuver, all electron controlled.



Electronic multiplier tube.

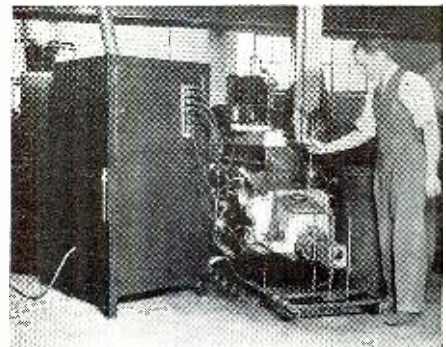

A vibrator tester used in auto manufacture is an electronic appliance.

Build Your Own Portable Phono-Radio

by **OLIVER READ, W9ETI**
Technical Editor, RADIO NEWS

For the man who would like to build a semi-portable phonograph-radio combination which will not need outside antennas, this unit will give hours of pleasure.

THE way to relax is to have a hobby; and having one, work it for all it is worth. There is not any question that one can purchase a unit similar to the one herein described at almost any radio store, and for the most part somewhat cheaper than it could be homebuilt. That, however, is not the point. The idea is to build—if that is your hobby—and to build as good as can be bought.

With that idea in mind, the author went about to duplicate the usual semi-portable phono-radio set. There is nothing so very outstanding about the resulting unit except that the parts which went into its construction are probably better than these going into the *cheaper* grade of manufactured unit. Since the components are of better grade, it stands to reason that the unit will give longer service and should stand up better. The construction is specially rugged, and the quality is excellent. It is the type of phono-radio which can be proudly displayed in the living room—not the homebuilder's cellar or den, and no excuses for its looks need be made.

Originally, it was intended to build only an electric phonograph, and then it was decided that since there was little difference in the ultimate cost between that and the inclusion of a small superhet receiver, that the radio set might as well be added. Portability in its entirety was discarded because no motor has yet been made available which will run any appreciable length of time on batteries. True, one could have used a spring motor to turn the record, but that, to the author, seemed a step backwards—away from electricity, and hence was not explored further. So the final set is one which is portable, but which must be used with a 115 volt a.c. source.

Since the case is made of wood and canvas construction, remarkably good quality was had from the 5" permanent magnetic speaker because the case made an excellent baffle. That in itself was something that is not always achieved in the manufactured product except in the higher price brackets. A loop for reception eliminated the necessity of stringing outside wires, unless one happened to be located where there were not any local broadcasting stations—which is a rarity in these United States.

The PM loudspeaker is mounted under the carrying case handle. One advantage of this location is that all protruding hardware etc., is kept on one side of the case. A piece of "cane metal" is cut to serve as a protection to the speaker cone. A piece of silk cloth is also fitted in back of this screen to keep out dust and metal particles, as well as to afford some protection from rain.

A 4½" hole is cut out of the case for the speaker. First it is necessary to mark off a circle on the airplane cloth

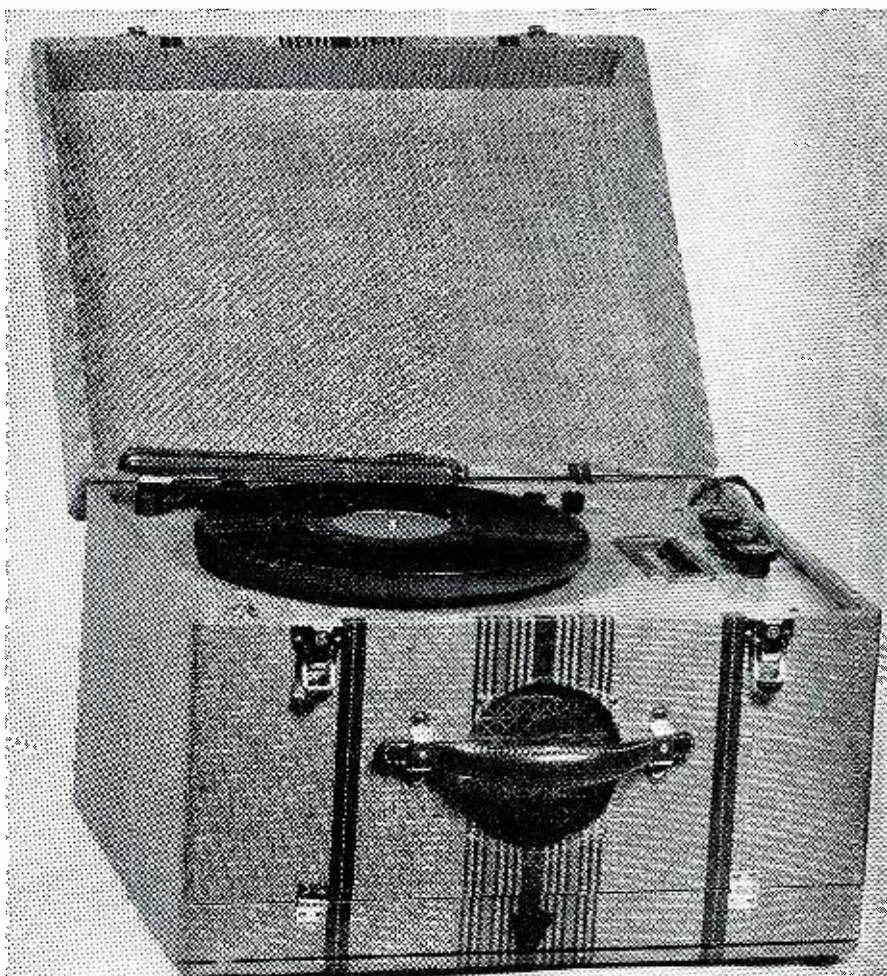

The case has a compartment at the bottom for records; includes whole unit.

of the case. Slits are cut through the material with a razor blade and then the material is folded-back so that the hole may be cut through the wood without damaging this material. The extra cloth is then folded back around the cutout and glued in place. If care is taken in the above procedure, the resulting effect will be as good as if the case had been done by the manufacturer.

If care is taken both in the design and construction of such a unit, the builder may effect a considerable sav-

ings. In order to obtain good quality from the various stations it is necessary that the receiver be able to pass the full band-width of the modulated carrier. This should be 10 kc. in width.

Most superhets include another intermediate stage to increase the selectivity of the entire IF system. In many cases the quality of the music suffers from the "lopping off" of the side bands which include the high audio frequencies. The receiver described contains but *one* IF stage. Sufficient gain is had for most signals, while the

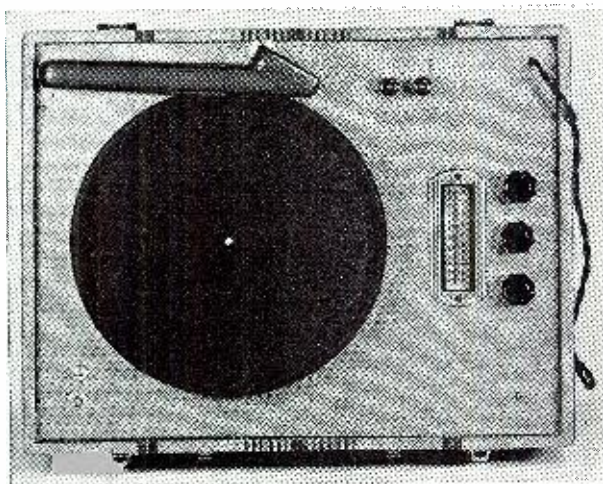

The layout of parts can easily be seen from this.

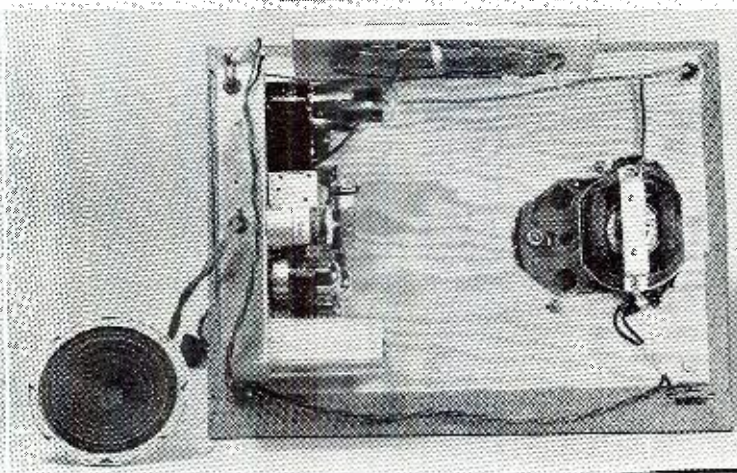

Under the motor-board view shows how the radio is mounted.

band-pass capabilities are widened to include the full 10 kc. band-width.

Automatic volume control is an essential and is included. The use of the latest "loktal tubes" prevents tubes from dropping out of their sockets when mounted on their sides. Furthermore, no tube shields are required. Metal tubes are not recommended for this particular unit. The lineup is as follows: 7A8 octode converter, 7A7 IF amplifier, 7B6 diode detector, avc, amplifier, 7C5 power amplifier, and a 5Y4G rectifier.

All parts and accessories are of standard make. Substitutions may be made if similar parts are available. Resistor tolerances are not critical, neither are those of the various condensers used.

Construction

The case may be obtained from a radio parts jobber, and in some instances, from a trunk dealer. It

should be large enough to house the turntable, speaker, chassis, and loop antenna. The first thing to be done is to find a suitable location for the p.m.

The speaker is a 5" Jensen p.m. dynamic with universal voice coil transformer. Taps are used which will match the 5000 ohm load of the 7C5 output tube. The unit is mounted with four 8-32 machine screws. Plenty of power output with good quality will be had from this speaker, even when used out-of-doors.

The phono turntable is of standard make. Made by *General Industries Co.*, it is rim-driven to provide a transfer of power to the table with good efficiency. The motor board must be cut to fit the particular assembly used. This is but a simple problem and will offer no difficulty to the builder. The phono pickup is an *Astatic* crystal type and is mounted as shown in the left rear corner of the case on the motor-

board. The phono-pickup must be placed at the proper distance from the hub of the turntable for proper tracking of the record. Set the pickup arm so that the needle swings in an arc across the record and over the hub.

Be sure to allow enough room so that the pickup arm will be free to revolve without striking the side of the case. A single $\frac{1}{2}$ " hole is all that is required to mount the pickup used. The motor assembly mounts above the motorboard and not below.

A starting switch may be located wherever convenient, but should be accessible to the user. The particular case used for our own unit has a record compartment built in to the lower portion of the case. This holds ten records of conventional variety.

The construction of the receiver follows usual procedure. No attempt was made to build a chassis that was not of standard size. The one used meas-

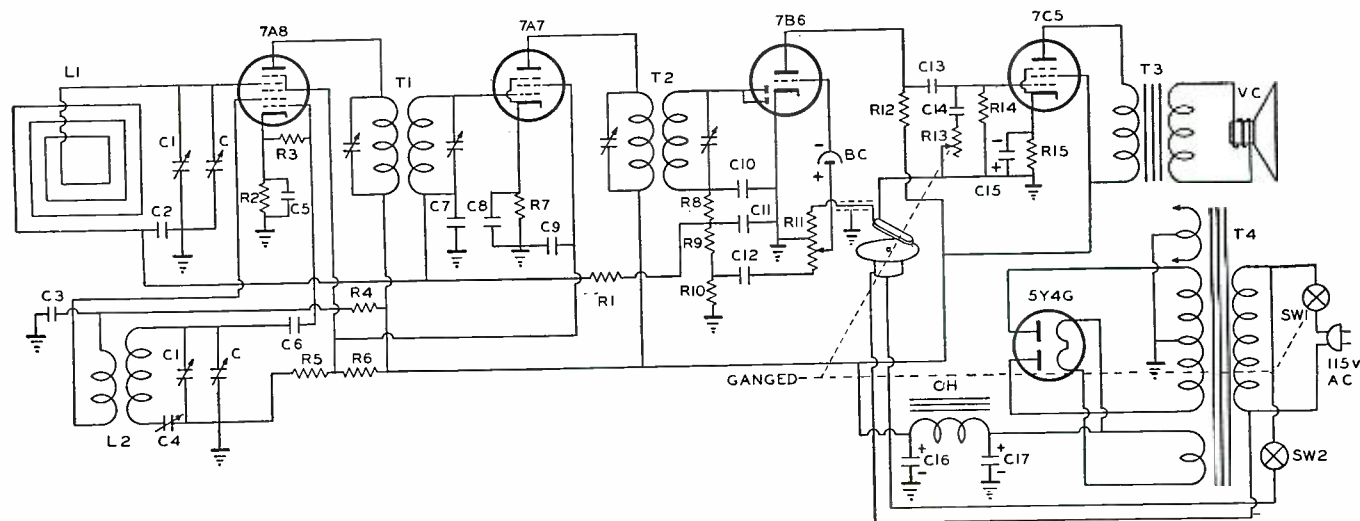

C—Trimmers on C₁ assembly
 C₁—Dual 370 mmf. cond. Allied B4141
 C₂—.05 mfd. 400 v. paper. Aerovox
 C₃—.005 mfd. 400 v. paper. Aerovox
 C₄—.0004 mfd. mica. Aerovox
 C₅—.01 mfd. 400 v. paper. Aerovox
 C₆—.0001 mfd. mica. Aerovox
 C₇—.05 mfd. 400 v. paper. Aerovox
 C₈—.01 mfd. 400 v. paper. Aerovox
 C₉—.02 mfd. 600 v. paper. Aerovox
 C₁₀—.0001 mfd. mica. Aerovox
 C₁₁—.0001 mfd. mica. Aerovox
 C₁₂—.01 mfd. paper. Aerovox

BC— $\frac{1}{4}$ v. bias cell.

C₁₃—.02 mfd. 400 v. paper. Aerovox
 C₁₄—.05 mfd. 600 v. paper. Aerovox
 C₁₅—20 mfd. 50 v. electro. Aerovox
 C₁₆, C₁₇—8-8 mfd. 350 v. electro. Aerovox
 R₁—2 megohms, $\frac{1}{2}$ w. IRC
 R₂—300 ohms, 1 w. IRC
 R₃—50,000 ohms, $\frac{1}{2}$ w. IRC
 R₄—40,000 ohms, 1 w. IRC
 R₅—40,000 ohms, 1 w. IRC
 R₆—30,000 ohms, 1 w. IRC
 R₇—300 ohms, 1 w. IRC
 R₈—100,000 ohms, $\frac{1}{2}$ w. IRC
 R₉—100,000 ohms, $\frac{1}{2}$ w. IRC

R₁₀—200,000 ohms, $\frac{1}{2}$ w. IRC
 R₁₁—500,000 ohms, center tap pot. Mallory
 R₁₂—50,000 ohms, 1 w. IRC
 R₁₃—250,000 ohms, pot. Mallory
 R₁₄—50,000 ohms, $\frac{1}{2}$ w. IRC
 R₁₅—450 ohms, 10 w. Ohmite
 L₁—Antenna loop. Allied B5798
 L₂—Oscillator coil. Allied B6586
 T₁—456 KC. input IFT. Allied B5837
 T₂—456 KC. output IFT. Allied B5843
 T₃—Pentode to voice coil trans.
 T₄—Plate and fil. Thordarson T-13R11
 CH—25 hy. Thordarson T-47C07

Carrying Case—Allied B16365

ures 10½" x 5" x 1½" and is constructed of steel. The parts are laid out as shown. The two-gang tuning condenser is fastened directly to the chassis to keep the overall height of the unit as small as possible. The slide rule dial requires that a cut-out be made in the chassis to accommodate the assembly. The bottom of this dial assembly is soldered to the chassis to prevent moving of the bracket.

The four bolts are removed from the *Thordarson* plate and filament transformer so that one of the half-shells can be mounted below the chassis. A cut-out is made for the transformer coil, the unit mounted, and the removed half shell bolted on from *underneath* the chassis. All of the filaments should be wired first, followed by the a.c. supply leads. It was necessary to cut away part of the flange on the chassis below the two controls as the diameter of these was a bit too large for fitting under a 1½" chassis. The tone control is provided with a switch for the a.c. primary circuit. No pilot lamp is required, as the sliderule dial is illuminated.

The thickness of the motorboard must be considered when cutting the extra shafting and it is best to leave this operation until the actual fitting is done. The receiver must be tested and aligned before it is mounted permanently to the board.

The best procedure is to use a test



Under chassis view of the radio.

oscillator and set the intermediate transformers to the proper frequency of 465 kc. The oscillator should then be set to 1500 kc. and the condenser gang plates fully opened. The *trimmers* are then adjusted to bring the signal on the dial at proper point. The test signal should then be set to about 600 kc. and the 400 mmf. *padding* condenser tuned for maximum signal with the condenser plates fully meshed.

Now return to high-frequency end of the band and re-set the trimmers for best results. Tracking should be uniform throughout the entire frequency range.

The set may also be aligned without the aid of a test oscillator by tuning to a station at the 1500 kc. end of the dial and by adjusting the trimmers for loudest signal. The tuning condenser should be "rocked" back-and-forth while this is being done. The process is repeated at the low-frequency end of the dial on another station that can be heard with satisfactory signal strength.

If a tuning condenser of another make is used, be sure that each section has a maximum capacity of 365 or 370 mmf. The *loop antenna* is the entire r.f. coil and is tuned. It comes with more than the usual number of turns. Some of these must be removed. A bit of experimenting will indicate

(Continued on page 57)



by ALFRED TOOMBS

Special Washington Correspondent for RADIO NEWS

Army Radio Maneuvers

THUGHTFUL officers have been studying a report circulated at the War Department recently describing the disruption of radio communications during maneuvers at the *Field Artillery School* by simulated "enemy intercept stations." The report leaves the disquieting impression that there is a good part of the Army's radio corps which doesn't know beans about how to use wireless under battle conditions.

Radio is a new and deadly weapon. It is largely untried in modern battle. The Army knows it can be highly useful—and highly dangerous. It is a two-edged weapon. Allowing inexperienced troops to handle radio communications in battle is as dangerous as turning a pistol over to a rookie who doesn't know which end the bullet comes out.

Radio, if improperly used in battle, may prove much more valuable to the enemy than to yourself. Naturally, the enemy is maintaining intercept stations. These stations attempt to break in on your frequencies. They may give false directions. They may jam the frequency to interrupt your communications. They may just listen to your commands.

It is an exciting duel. But there are means to prevent the enemy from doing all these things. Troops which have learned proper radio discipline can outwit the enemy.

The disturbing revelation contained in the report from the *Field Artillery School* is the obvious fact that the radiomen—and they are average, typical troops—disregarded the fundamental rules with the result that, had they been in battle, their outfits would have been wiped out.

The practice sessions were average, with radio employed to direct the fire of field artillery pieces. The radio sets in different units were formed into nets, over which ranges and orders were transmitted. Some of the nets included airplanes, which were carrying out bombing or observation missions in cooperation with the ground troops.

Situated where enemy intercept stations would be were instructors from the radio school, who told the men in advance that they would attempt to break up their communications. Here are some of the results, as set forth in the report:

Interference Breaks Up Maneuver

ONE interference station, after finding the frequency being used for contact between a plane and the ground net, transmitted an unvarying tone signal which broke up the contact completely.

Breaking in on another net, the interference station broke it up too. One operator on this net finally sent this plaintive message:

"This is Simpson. What should I do? I'm sitting up here on top of this damned hill with no one to talk to and nobody to work with."

The interference station was quick to reply:

"Close up your set and go home."

"Okay. Am closing station."

And he did!

One station, battling interference set up by the "enemy," spent thirty minutes—transmitting a 10-word message. In another instance, the interference station checked into a net to inform the other stations as they checked in that one was "100 kilocycles too high" and another "75 kilocycles too low."

One net was tied in with an airplane, which was to direct artillery fire. The interference station, posing as the plane, actually directed the firing of five rounds—on

false objectives—until a brass hat who was in the plane angrily ordered the station to cease interference.

Once, when an interference station was giving false orders by posing as a member of the net, the station whose call letters interference was using broke in and the exchange went like this:

5W: "Hey, Fliver, that wasn't me giving those last commands."

4V: "Who was it, then?"

Interference: "The mission is okay, Fliver."

5W: "No it ain't, Fliver. That wasn't me talking. Cease firing."

4V: "Will not fire problem, due to uncertainty of data."

And so the mission was ruined. Later, the interference station got stations on one net so confused that they refused to answer calls from anyone. In its conclusions, the report makes this startling statement:

Army Radio Report

IT is entirely possible for an enemy, using radio equipment of no more power and similar to our own radio sets, to delay, disrupt, confuse and even prevent the use of our present radio communication."

Further, the report said:

"It is impossible to prevent hostile radio interference and radio intercept as long as the artillery is provided with its present type of equipment."

The report places its fair share of blame on the lack of radio discipline on the men. One of their chief mistakes had been in sending too many messages "in the clear." Army regulations require that field messages be encoded, unless there is an emergency which prevents spending that much time or unless the message is such that it would do the enemy no good if he intercepted.

The Germans, in their campaign through the Lowlands and France, threw radio discipline to the winds and sent almost everything "in the clear." Much has been made of this, but Army men believe that there is no deep mystery. The opposing Armies were so disorganized that caution in transmitting messages was not even necessary. The Germans have strict radio discipline—but they did not need it.

It is easier to relax discipline, once it is mastered, than it is suddenly to enforce it—where laxity has been the habit. So say the Army officers who studied the field artillery report.

Moving Day, March 29

SERVICEMEN: Those of you who don't have the cash register stuffed by April 1 should celebrate April Fool's—with yourselves as guests of honor.

D.C. Board Squabble

THERE'S a nice squabble going on behind the scenes at the *Defense Communications Board*—and the hams are in the middle.

The Board, in charge of preparing our national radio defense has a number of sub-committees, acting as advisors. One of these is the Labor Advisory Committee. Another is the Amateur Radio Committee.

The C. I. O. representative on the Labor Committee is Joseph P. Selly, ACA prexy. The A. F. L. is represented by Robert J. Watt and the Federation of Telephone Workers by Paul E. Griffith.

CIOMan Selly started a campaign within his committee to get it to recommend the appointment of a labor representative on the Amateur Committee. Messrs. Watt and

(Continued on page 54)

Another Example for Quality

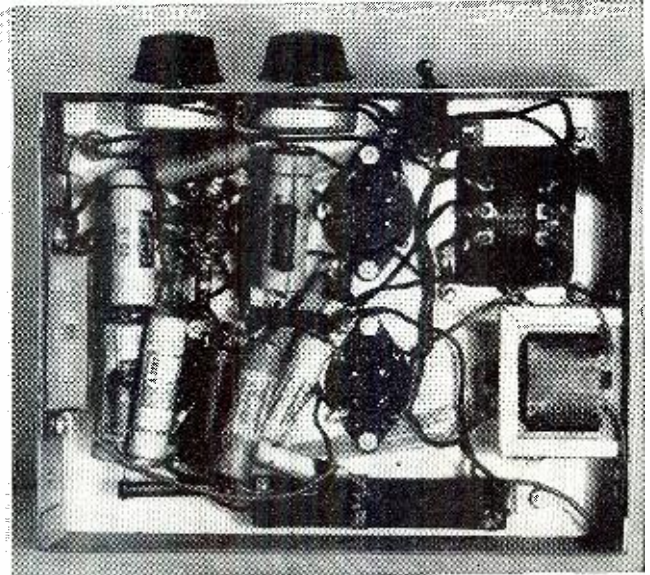
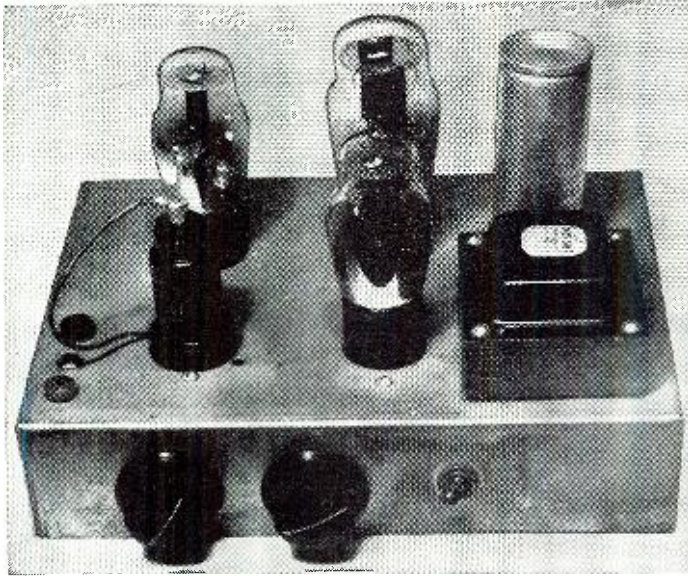

Simple to build, this unit will improve your radio's quality.

by **L. M. DEZETTEL**

Engineer, Allied Radio Corp.,
Chicago, Illinois.

By connecting this unit to your radio receiver you will hear that which was lost.

MODERN audio amplifiers and high-priced radio sets now employ volume expanders to restore the true relationship of tone intensity in musical selections originating either from radio broadcasts or from phonograph records. The volume expander builds up louder passages and restores the balance between loud and soft passages such as would be heard in the original "in person" performance.

The necessity for volume expansion is obvious when one considers the process involved either in radio broadcasting or in recording. In either case the process results in a compression so that the sound can be carried along transmission lines (in the case of broadcasting) or be impressed in record grooves (in the case of recording). Now, unless volume expansion is used, the radio performance or the phonograph record will not reproduce the full *depth* and tonal *contrast* of the original performance. However, when expansion is used, the reproduction of the performance reveals surprisingly improved fidelity.

This volume expander has been designed to provide a simple and convenient method of volume expansion for radio sets or record players, and may be used with almost any set or amplifier. The circuit outlined in the schematic diagram is very simple and the unit itself may be easily constructed.

Firstly, mount the sockets and larger parts on the chassis. Then proceed with the wiring as indicated in the schematic diagram. It is a good idea to use a colored pencil to check off on the diagram each lead that has been completed. In this way you can avoid the possibility of overlooking any lead.

When the wiring has been com-

pleted, make a final check of the complete circuit against the diagrams. This last check will serve to reveal any errors which may have been made in wiring. The expander may now be bolted permanently to the inside of the console cabinet.

In case the volume expander is used in connection with a phonograph pickup, the pickup itself may be connected

directly to the unit. The *output* of the volume expander unit is of the *high-impedance* type and may be connected directly to the input of the amplifier or audio portion of your receiver the same as you had previously connected the pick-up.

For connecting into your radio, to expand radio broadcasts, a slight "open" (Continued on page 56)

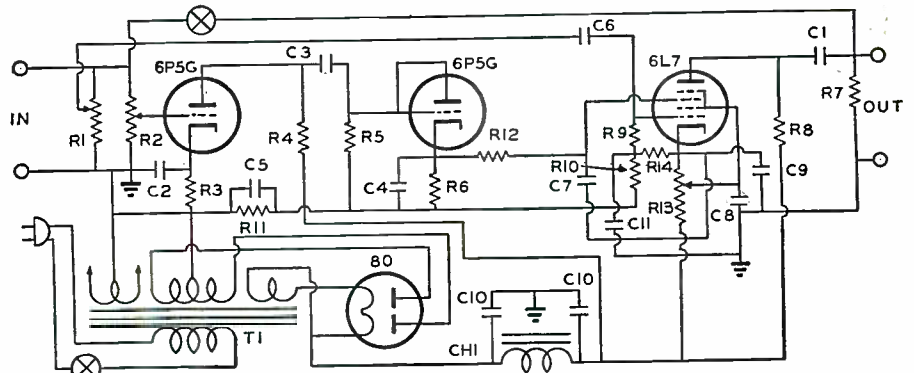

R_1 —1 Megohm pot.
 R_2 —1 Megohm pot.
 R_3 —10,000 ohms, $\frac{1}{2}$ w.
 R_4 —100,000 ohms, $\frac{1}{2}$ w.
 R_5 —100,000 ohms, $\frac{1}{2}$ w.
 R_6 —250,000 ohms, $\frac{1}{2}$ w.
 R_7 —1 megohm, $\frac{1}{4}$ w.
 R_8 —100,000 ohms, $\frac{1}{2}$ w.
 R_9 —1 megohm, $\frac{1}{4}$ w.
 R_{10} —100 ohms, 1 w.
 R_{11} —100 ohms, 1 w.
 R_{12} —500,000 ohms, $\frac{1}{2}$ w.
 R_{13} —10,000 ohms, 50 w. adj.
 R_{14} —400 ohms, 2 w.
 C_1 —.05 mfd. 600 v. paper.

C_2 —.5 mfd. 200 v. paper.
 C_3 —.01 mfd. 600 v. paper.
 C_4 —.5 mfd. 200 v. paper.
 C_5 —.5 mfd. 50 v. electro.
 C_6 —.05 mfd. 600 v. paper.
 C_7 —.5 mfd. 200 v. paper.
 C_8 —2 mfd. 550 v.
 C_9 —.5 mfd. 50 v. electro.
 C_{10} —8.8 mfd. 550 v. electro.
 C_{11} —.5 mfd. 50 v. electro.
 T_1 —650 v. @ 40 ma., CT, 5 v. @ 2A., 6.3 v. @ 1.6A. CT.
 CHI —25 henry, 50 ma.
 Chassis—7" x 9" x 2".
 Note: The author used "Knight" parts. "Knight" is the trademark of Allied Radio Corp., Chicago.

A HAM BUILDS HIS OWN Communication Receiver

by Bill Davis, W5GHU

Here is an excellent receiver for the amateur who wants to build a little at a time. Improvements can be added later.

WHEN a new receiver was contemplated for the station, both for hamming and for general listening around, I decided to build my own, after looking over the available receivers, especially after looking at the price tags attached thereto.

In designing the receiver, one of the first requirements was that it could be built gradually. The basic unit was constructed, and refinements added as my finances permitted. Also the complete receiver should cost less than one hundred dollars and give topnotch performance. I think I've come pretty close to that goal. The complete receiver will cost from seventy to ninety dollars, less coils, depending upon finishing touches used. Coils can be made up for from five dollars to twelve and a half dollars per band, varying with the type of trimmers used and how many are needed. The coils used in this receiver cost about six dollars for the general coverage units and about seven dollars fifty cents for the band-spread coils.

The receiver was first built up minus the crystal filter, built-in power sup-

ply, and with only one set of coils. This made it relatively cheap to get started hearing signals and the refinements and extra coils have since been added. Just a nice way of buying a receiver on the installment plan. Large performance claims are customary, but I'll only say for this one that I've compared it with several commercially built communications receivers and still don't think I'd trade anybody for one of them. Perhaps, though, I am biased.

Getting down to the actual design, the main use I have for a receiver is to work a few stations on phone once in awhile, and do a lot of listening, mostly on phone. I like to hear a little *dx* once in awhile, too, even if I can't work much of it. So plenty of gain and a good signal to noise ratio would not be out of place. Being on phone, I managed to get along without the crystal filter for awhile and just left room for its later inclusion in the original layout.

For good sensitivity and signal to noise ratio (don't forget images here), two stages of r.f. gain were used ahead of the first detector in preference to

one, and since maximum gain is easier for the home constructor to get with plug-in coils and the home-built receiver is more flexible in its frequency coverage with them, ganged front-of-panel plug-ins were used. I'm not trying to pick a brawl with the band-switch addicts, but merely think that there are a lot fewer headaches in a two-stage high gain amplifier home-built with plug-ins than in one where a band switch is used.

I used the *National* "PW" dial for its fine calibration and ability to reset to a station without looking across the band. The dial, by the way, is mounted low enough on the panel so the receiver can be tuned without developing a special set of "elbow calluses."

Automatic volume control is almost a necessity, and the system used here has worked out very well so far. The avc channel admits a slightly wider frequency band than the signal channel, which results in a "quiet" sounding receiver when tuning from one signal to another. No sudden blast of noise when a signal is left, and an easy method of control over the degree of a.v.c. are its chief advantages.

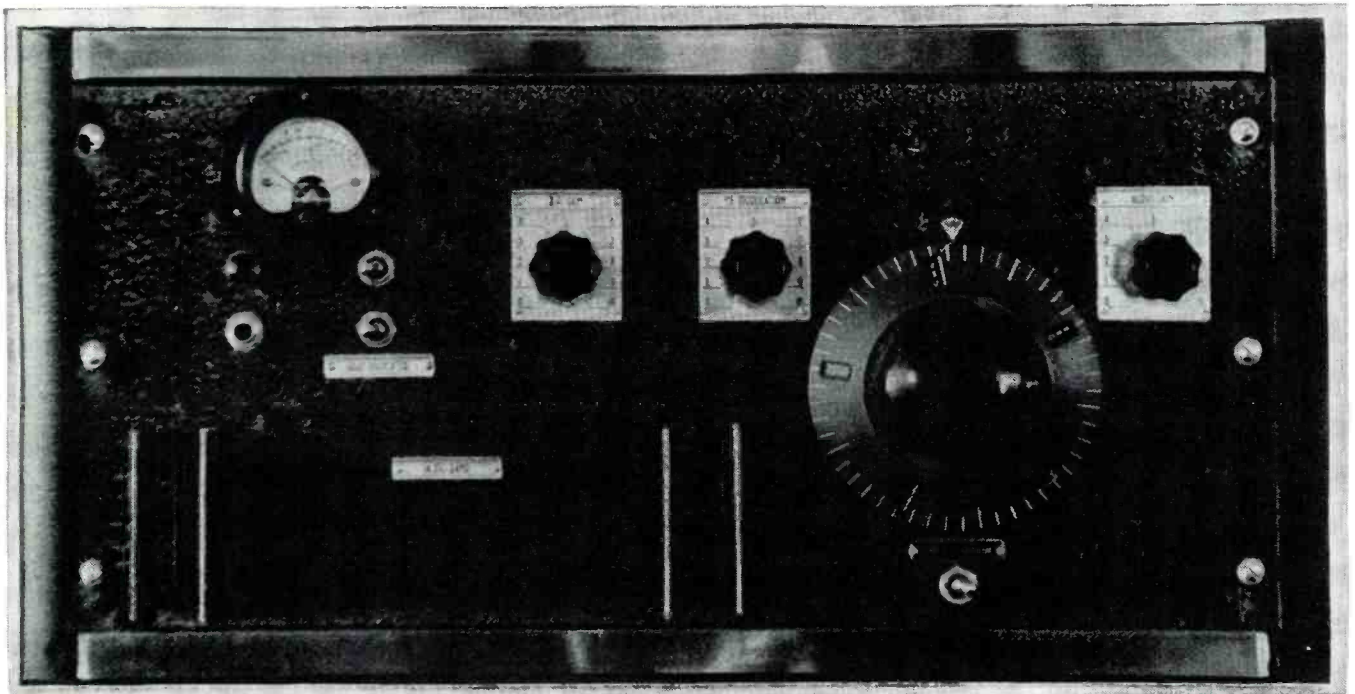

One would never suppose this was a home-built receiver, it looks so commercial.

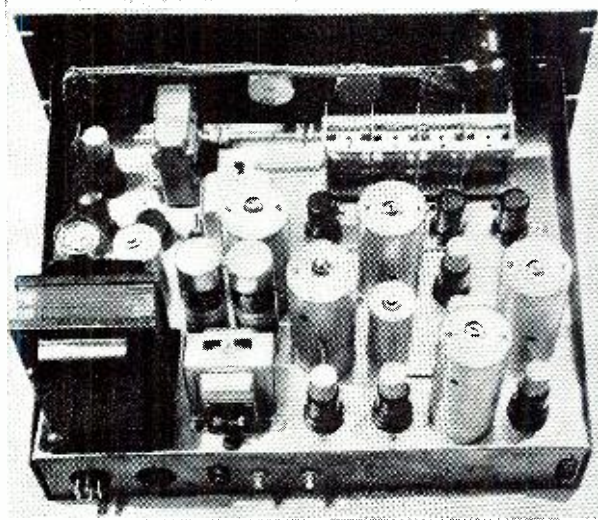

A beautifully laid out chassis.

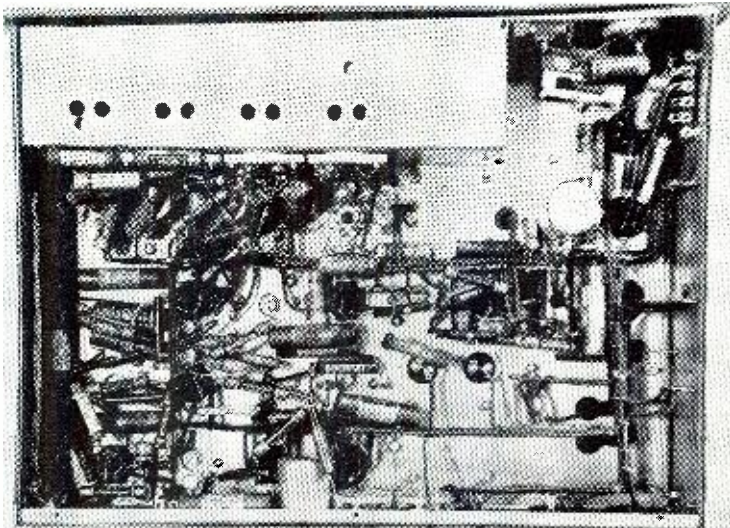

Underchassis view of the communication receiver.

Its only apparent disadvantage is the tendency for a strong signal a few kilocycles removed from the one to which you are listening to take over the gain control. This is rarely evident to an objectionable degree, and when it is, the avc-manual switch cures the difficulty.

A balanced bridge type "R" meter is used to read carrier strength. The circuit is arranged so the meter swings up with an increase in signal, and even inquisitive fingers are fairly safe as the voltage from meter to ground is only about three volts.

The 465 kc. i.f. amplifier was chosen for a number of reasons. With two stages of r.f. ahead of the mixer, the images shouldn't be too bad. Another reason is that the 465 kc. transformers were already on hand, which is also the reason air-core coils were used instead of iron-core. If a higher i.f. frequency had been used it might have been necessary to use three stages to get the required gain and selectivity. A happy bi-product of this choice of frequency is that 465 kc. crystals for the filter are considerably cheaper than they are for other frequencies.

Remembering the crystal filter, the noise silencer is arranged to take out the noise in the first i.f. amplifier, and the crystal is put between the first and second i.f. amplifiers. Except for the crystal filter one of the audio limiting types of noise silencers would probably be just about as good as the type used here. The two-stage amplifier on the noise silencer is not quite a necessity, but the extra stage allows the unit to be more thoroughly controlled by the avc, and removes a lot of knob twisting in taking the noise out of a fading signal. Even with the first i.f. amplifier run at reduced gain, there is plenty of gain left to reach the tube noise level in the mixer-oscillator combination.

The power supply is built-in, although some frequency stability might thereby be sacrificed. After the initial warming-up period, most of the drifting stops. The speaker field does not form part of the filter system, so if the "portable urge" gets me, the receiver and a pair of phones are all I need. Choke input on the power supply minimizes voltage changes when either the avc or the manual gain control varies the current drain of the re-

ceiver. A VR150 tube may be used on both oscillators for extreme stability.

The tube layout is quite conventional, and is given below:

6SK7—first r.f. amp.; 6SK7—second r.f. amp.; 6SA7—mixer; 6SJ7—h.f. osc.; 6L7—first i.f. amp.; 6K7—second i.f. amp.; 6J7—triode detector; 6J7—beat oscillator; 6J7—triode a.f. amp.; 6F6—second a.f. amp.; 6K7—first noise amp.; 6J7—second noise amp.; 6H6—noise rectifier; 6B8—avc amp. and rect.; 5Z3—h.v. rectifier.

Both oscillators are electron coupled. The 6J7 triodes are used for the detector and first a.f. amp. because the 6C5's used at first showed a more than slight inclination to be microphonic. The detector is of the biased triode type, with audio degeneration (infinite impedance), and has only slightly more audio output than a diode, but it doesn't put a resistance load across the last i.f. transformer, which helps the selectivity nearly as much as an extra stage of i.f. gain. The audio quality from this detector is good enough for a broadcast receiver, and is certainly sufficiently good for a communications receiver with a six-inch speaker!

The headphones are coupled to the output of the first a.f. amplifier through a blocking condenser so no d.c. is present to threaten either the crystal phones or the life and limb of the user. Both the audio gain and the tone controls have the same effects whether speaker or phones are used. Plugging in the phones grounds the grid of the output tube to silence the speaker.

A look at the receiver shows that the ganged coils plug in at the lower left of the panel, with tuning dial just to the right. The dial is far enough over to leave plenty of room to insert and remove the coils, and low enough to be easy to tune.

An explanation of the controls is here in order. The knob to the lower right of the dial is the tone control and a.c. switch; upper right, audio gain. Above the dial on the left are the noise silencer and sensitivity controls. The toggle switch below the dial breaks the plate voltage supply, and of the two at the upper left, the lower one controls the beat oscillator, and the upper one is the a.v.c.-manual volume control switch. To the left of these are the pilot light and the phone

jack. The knobs for adjusting the meter to zero and for adjusting meter sensitivity are on the rear of the chassis.

Antenna and ground connections are brought out to a three terminal strip at the left rear corner of the chassis so either doublet or single wire fed antennas can be used by proper connections. In the broadcast and lower frequency short wave coils the antenna coil primary is connected from one side of the doublet (upper terminal on the strip) connections to ground. In this way, with most of the receiving done on doublets for one or two bands, changes in antenna connections for listening on other bands are eliminated.

Speaker connections are brought out to a five-prong socket on the chassis apron, and the a.c. line cord is connected to a four-prong male wafer socket next to the speaker socket. Terminals are also provided on the chassis apron for connecting part of the regular transmitter switch in series with the receiver plate supply.

The ganged plug-in coils are made up from four shield cans with six-prong plug-in bases, clamped in a galvanized iron channel. The iron channels for the various coils were all obtained at one time from a local tinsmith. Having a tinsmith make these up is almost as cheap as doing it at home, and the channels are all the same width and just fit the coil shields. A small panel is put on the front of the coil unit to match the panel of the receiver. Handles for the coils are made from 3" long pieces of 5/8" diameter iron rod, drilled and tapped so an 8-32 machine screw can be run through the galvanized channel, front panel, a 5/8" long brass tubing spacer, and into the back of the handles, holding the assembly together. A set of similar handles is put on the receiver, to the sides of the coils, for something to anchor to when changing bands. The handles are large enough to get a good grip on, so there isn't much chance of slipping off and acquiring a ruined thumb.

After the coil mounting assembly is finished, the individual coil units can be mounted in the channel. They have to project from the mounting at right angles, and similar prongs on each plug base must be 2 1/8" apart or the coil unit will bind on the panel or be

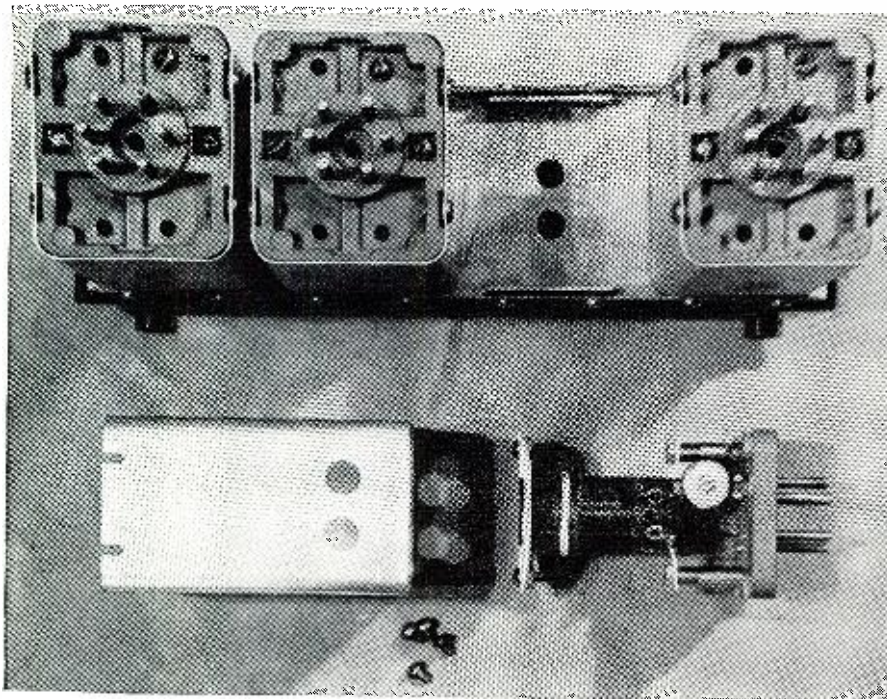

Constructional details of the coil forms.

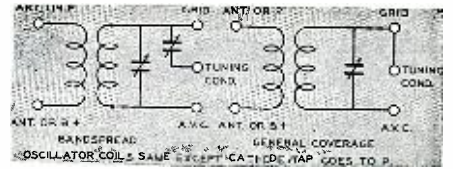

Band-change circuit diagram.

the bottom of each coil shield and in the overall shield so the trimmers can be adjusted with something less than a major operation. A different type tuning condenser might permit mounting the trimmers so they could be reached from the top, which would be much more convenient when alignment time comes around.

Due to the close spacing in the coil socket, tube socket, and tuning condenser assembly, the high frequency wiring is all very short and direct. All the wiring in these stages is run point to point without too much regard for appearance. Each stage has all its ground returns made to a single point on the chassis near the tube concerned. All grid and plate leads are about an inch long, which is no handicap on the higher frequencies.

The r.f. wiring below the chassis in the i.f. stages is all shielded and run as directly as possible. All the filament and power supply leads are cabled, as are all the leads to the panel controls.

Inspection of the diagram shows that all stages are thoroughly decoupled. From previous receivers it was decided that with so many stages packed in next to each other, complete decoupling of nearly every stage would be needed. It was put in to begin with, and most of the usual period between the completion of a receiver and the stoppage of the undesired oscillations was avoided. The screen decoupling resistors are made to do double duty and drop the high voltage to a safe value at the same time they decouple. Plate decoupling resistors are less

(Please turn to page 58)

very hard to insert and remove. If they're very far off the coil units may not plug in at all. The shield cans are $4\frac{1}{8}$ " long when purchased and are cut off at the top so the can itself, exclusive of prongs, is $3\frac{5}{16}$ " long. The completed coil units are $8\frac{3}{4}$ " wide, $2\frac{3}{8}$ " high and $3\frac{1}{2}$ " deep, counting the front panel, but not the prongs or handles.

A combination socket support and overall shield was made from a $10\frac{1}{2} \times 12\frac{1}{2} \times 3$ " chassis. It was cut down until I had an L shaped shield with the ends closed in. The dimensions of this shield are $12\frac{1}{2}$ " wide, 3" high, and $3\frac{5}{16}$ " deep. The $3\frac{5}{16}$ " dimension, as well as the length of the coil shield, are tailored to fit the tuning condenser. If a tuning condenser had been used which needed

more or less chassis depth to mount, these dimensions would have been altered to fit the changed condenser. The overall shield unit is placed upside down in the left front corner of the chassis, with the sockets for the coils mounted on the back side directly below the tube sockets and the tuning condenser. The best way to get the dimensions on this part of the receiver is to mount the dial and tuning condenser on the chassis and make approximate measurements. Then make up one set of coils and tailor the overall shield unit to this set of coils. All that is necessary then is to see that all later coils are mechanical duplicates of the first set.

Holes $\frac{3}{8}$ " in diameter are drilled in

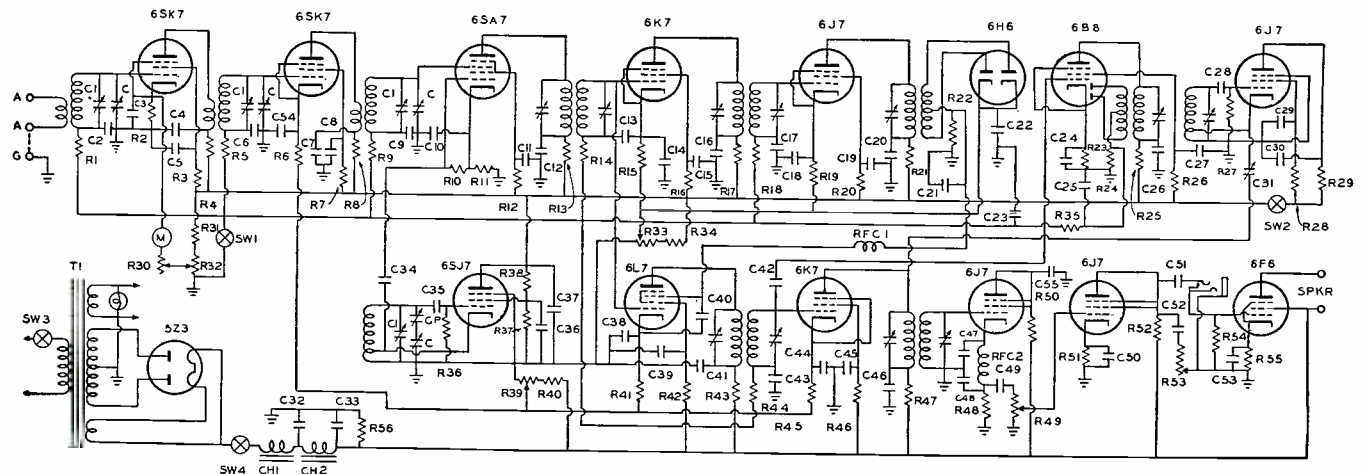

- C₁—370 mmf. variable. Allied.
- C₂—30-100 mmf. padders. Hammarlund.
- C₃, C₄, C₅, C₆, C₇, C₈, C₉, C₁₀, C₁₁, C₁₂, C₁₃, C₁₄, C₁₅, C₁₆, C₁₇, C₁₈, C₁₉, C₂₀, C₂₁, C₂₂, C₂₃, C₂₄, C₂₅, C₂₆, C₂₇, C₂₈, C₂₉, C₃₀, C₃₁, C₃₂, C₃₃, C₃₄, C₃₅, C₃₆, C₃₇, C₃₈, C₃₉, C₄₀, C₄₁—600 v. paper. Sprague
- C₃₂—0.0005 mfd. mica. Sprague
- C₃₃—0.001 mfd. mica. Sprague
- C₃₄—0.05 mfd. mica. Sprague
- C₃₅—5-30 mmf. padder. Hammarlund.
- C₃₆—12 mfd. 550 v. electro. Aerovox

- C₃₇, C₃₈, C₃₉—0.001 mfd. mica. Sprague
- C₄₀, C₄₁—50 mmf. mica. Sprague
- C₄₂—0.0025 mfd. mica. Sprague
- C₄₃—10 mfd. 50 v. electro. Aerovox
- R₁, R₂, R₃, R₄, R₅, R₆, R₇, R₈, R₉, R₁₀, R₁₁, R₁₂, R₁₃, R₁₄, R₁₅, R₁₆, R₁₇, R₁₈, R₁₉, R₂₀, R₂₁, R₂₂, R₂₃, R₂₄, R₂₅, R₂₆, R₂₇, R₂₈, R₂₉, R₃₀, R₃₁, R₃₂, R₃₃, R₃₄, R₃₅, R₃₆, R₃₇, R₃₈, R₃₉, R₄₀, R₄₁, R₄₂, R₄₃, R₄₄, R₄₅, R₄₆, R₄₇, R₄₈, R₄₉, R₅₀, R₅₁, R₅₂, R₅₃, R₅₄, R₅₅—1000 ohms, 1 w. IRC
- R₂₇, R₂₈, R₂₉, R₃₀, R₃₁, R₃₂, R₃₃, R₃₄, R₃₅—50,000 ohms, 1 w. IRC
- R₃₆, R₃₇, R₃₈, R₃₉, R₄₀, R₄₁, R₄₂, R₄₃, R₄₄, R₄₅, R₄₆, R₄₇, R₄₈, R₄₉, R₅₀, R₅₁, R₅₂, R₅₃, R₅₄, R₅₅—5000 ohms. pot. Mallory
- R₄₉, R₅₀—500,000 ohm. pot. Mallory
- R₅₁—500,000 ohms, 1/2 w. IRC
- R₅₂—500 ohms, 10 w. Ohmite
- R₅₃—25,000 ohms, 50 w. Ohmite
- M—O-1 DCMA Triplett
- CH₁—25 Hy. Swinging choke. Stancor
- CH₂—25 Hy. Filter choke. Stancor
- SW₁, SW₂, SW₃, SW₄—SPST Toggles

- R₁₇, R₁₈, R₁₉, R₂₀, R₂₁, R₂₂, R₂₃, R₂₄, R₂₅, R₂₆, R₂₇, R₂₈, R₂₉, R₃₀, R₃₁, R₃₂, R₃₃, R₃₄, R₃₅, R₃₆, R₃₇, R₃₈, R₃₉, R₄₀, R₄₁, R₄₂, R₄₃, R₄₄, R₄₅, R₄₆, R₄₇, R₄₈, R₄₉, R₅₀, R₅₁, R₅₂, R₅₃, R₅₄, R₅₅—1000 ohms, 1 w. IRC
- R₂₇, R₂₈, R₂₉, R₃₀, R₃₁, R₃₂, R₃₃, R₃₄, R₃₅—50,000 ohms, 1 w. IRC
- R₃₆, R₃₇, R₃₈, R₃₉, R₄₀, R₄₁, R₄₂, R₄₃, R₄₄, R₄₅, R₄₆, R₄₇, R₄₈, R₄₉, R₅₀, R₅₁, R₅₂, R₅₃, R₅₄, R₅₅—5000 ohms. pot. Mallory
- R₄₉, R₅₀—500,000 ohm. pot. Mallory
- R₅₁—500,000 ohms, 1/2 w. IRC
- R₅₂—500 ohms, 10 w. Ohmite
- R₅₃—25,000 ohms, 50 w. Ohmite
- M—O-1 DCMA Triplett
- CH₁—25 Hy. Swinging choke. Stancor
- CH₂—25 Hy. Filter choke. Stancor
- SW₁, SW₂, SW₃, SW₄—SPST Toggles

A S I D E S E E I N

by **JOHN F. RIDER**

Dean of the Servicemen



John F. Rider

Square Wave Signal Sources

URING a recent lecture at the Radio Club of America, in New York City, Lincoln Walsh spoke about the design of a new type of audio amplifier, new type of speaker and other details pertaining to sound amplification. A number of very significant details were brought out in this lecture, one of which, for some reason or other stuck with us more forcefully than the rest, although everything was of excellent character. Perhaps it was because of the fact that we have a secret passion for test equipment in general. Anyway, one part of the lecture spoke about the definite advantage of testing audio amplifiers with a square wave generator.

What intrigued us was the statement that mayhap many an amplifier which is infected with distortion when the gain is turned up, is suffering from overloading at some frequency far out of the audio spectrum, with the result that the trouble seems to be of mysterious nature. No amount of testing over say, the 30 to 15,000 cycle range brings the trouble to light. In the amplifier Walsh described a transient developed at around 80,000 cycles and its amplitude was sufficient to cause overloading, although the amplitude of the other frequencies being passed through the amplifier was below the point where overloading would appear.

The possibility of developing such transients in modern day audio amplifiers is quite prominent in view of the general tendency towards inverse feedback and the phase shift that takes place in such feedback systems changes with frequency. Hence what may be normal operation over the regular audio frequency range, may develop into very poor operation at one of the higher harmonics of an audio signal. One or more circuits may be resonant to some supersonic frequency and since the normal signal level in the modern-day audio amplifier is quite high, the amplitude of oscillations set up in these resonant circuits may be amplified more and overload the output stage.

In discussing the problem of distortion with different people, it was surprising to learn, that to many men who have done service work upon radio receivers, that this one particular problem seemed baffling. This was the reason for distortion in some receivers with a fairly high output rating, when the receiver gain control was advanced, but still far from maximum. Normal investigation of conditions did not show any definite fault and the only solution seemed to be operation below the point where the distortion set in.

Some might feel, as we did at first, that such tests upon audio amplifiers can be made with a sine wave signal source capable of developing signals over the audio and supersonic ranges. In this way instantaneous identification of the frequency at which oscillation develops would be automatically

identified. However, it seems that the square wave generator used with an oscillograph gives not only faster means of operation, but as the consequence of the nature of the wave being passed through the amplifier, the development of transients in such resonant circuits is expedited.

This subject of oscillation in audio amplifiers used with inverse feedback circuits has been mentioned at different times in different radio publications and sundry solutions were offered, so that possible remedies are known. But it is not the remedies in which we are interested. Instead it is in the possibility of the square wave generator or at least a square wave signal source becoming a service instrument. With such a signal source, the oscillograph, so long a neglected device would find application. Identification of the frequency of oscillation, so useful in furnishing a clue to what possible circuit is responsible for the condition, could be made with a multi-range resonant circuit and an indicator such as are used in signal tracing apparatus.

As to the source of the square wave signal, a suggestion for contemplation by those who might concur in the thought that a square wave signal source might be practical, is the utilization of a dual vacuum tube slipper system which could be used with the sine wave audio oscillators now in the possession of servicemen. This would provide a square wave signal source for comparatively little money. We'll venture the comment that square wave signals will find use in service work. Incidentally, signal tracing works admirably when tracing high frequency oscillation in audio systems, irrespective of the source.

Frequency Reallocation

WELL, the fateful day is drawing nigh. 'Tis to be March 29th. On that day the new frequency allocations go into effect and several millions of receivers will require service—the type that does not have to be sold—the type the public realizes of their own will, is necessary. The fear that John Q. Public will not call for resetting of the push-buttons, because they will be content with manipulation of the tuning knob, is not well founded. Once you got get used to pushing buttons, the other way is entirely too cumbersome.

But what will servicemen do? Will

they knock the charge down to some insignificant level because of the comparative ease of making the adjustment? Will they forget to make arrangements with all of the tenants in a building to call on the same day to reset their receivers, A card or two, placed into the mail box of each tenant a month before, and then two weeks before reallocation day will more than likely do the trick. Maybe an arrangement with the superintendent of the building to ascertain how many push-button receivers are in the building will enable the wideawake servicemen to establish a reasonable figure to assure the job. It can be on a quantity basis for it takes but one call to the building to contact every customer. But this does not mean that a resetting job can be done for 15 cents. It should depend upon the receiver. Midgets should be one price, and larger receivers another price, with perhaps a scale based upon the number of buttons on the receiver.

It is well to bear in mind that some large receivers may be easily adjusted, but that others require a bit of gymnastic work to get to the trimmers. We mention this only as a warning against forming a hasty opinion based upon some recent receivers which have been brought into the shop.

Will servicemen called in to reset push-buttons miss the opportunity of gathering facts about the receiver for what it may be worth during a future call? Will they miss the opportunity of estimating the number of receivers in a given area? It's a swell chance to secure information about the receiver population of your trade.

Let's hope servicemen will not miss the boat! It's been a long time since the day when the customer was prac-

(Continued on page 62)

WHEN RADIO GETS YOU, IT REALLY GETS YOU!

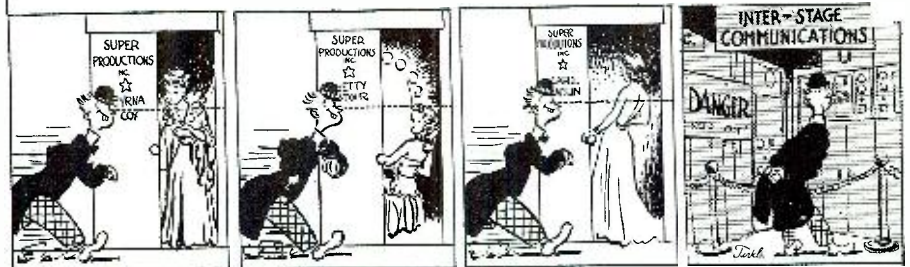

Homebuilt Electronic Volt-Ohmmeter

VERY radio service engineer who owns the new *Rider-RCA Voltohmyst* or any similar electronic volt-ohmmeter knows only too well how really valuable such an instrument can be. In fact, it is almost an absolute necessity in modern radio servicing. It is for those servicemen who recognize that fact, that I have designed and built a low cost combined electronic volt-ohmmeter similar to it.

Firstly, I wish to state that the basic circuit diagram is like that of the *Rider-RCA Voltohmyst*, and I do not claim any right to it. However,—I do claim absolute originality for all the resistor and capacitor values and to the tube arrangement used in my circuit, as not one single resistor or capacitor value, each for each, will correspond to that of the *Rider-RCA* job. Due to the different meter movement resistances, and to the series filament connection, together with entirely different tube characteristics,—it was necessary for me to engineer every value. I do not claim that this unit is as good as the *Rider-RCA* one, although I do know that it is a close second.

The electronic volt-ohm meter will accurately measure to 1000 megohms and to 1000 volts d.c. The resistance ranges are covered in seven steps. The ohms scale is at the top and is lettered in red. Range number one is calibrated from zero to 1000 ohms at about full scale. Range number two is ten times that of number one; range three multiplies by 100; number four is 1000 times; number five multiplies by 10,000 times; number six is 100,000 times and number seven is 1,000,000 times that of readings on scales. There is no need to readjust the ohms-adjust control when changing from one range to another. One feature is that it is impossible to damage the meter movement in any way, whether the "ohms input" is used for voltage tests accidentally, or in case the radio under test should happen to be left "on." Then too, very accurate resistance readings can be made in the "R1" position where 10 ohms falls at center of scale.

For fairly good accuracy I have used wire-wound 5% tolerance resistors for first three ranges and 5% tolerance Semi-Precision ones for last four ranges. One per cent tolerance ones can be used at slightly more expense although in my opinion that is not necessary because the average constructor will not have any exact necessity for such accuracy.

The voltmeter section is quite stable; and it, too, doesn't need any zero resetting whenever switching from range to range. There are eight overlapping ranges: 0-5 volts, 10, 25, 50, 100, 250, 500 and 1000. The resistors used in all these ranges are merely good quality ones as are used in service work. The reason for this is that each range was individually calibrated.

For greater sensitivity and accuracy I have used the new *Amphenol Co-axial* cable connectors and chassis connector together with Co-axial cable. A one megohm resistor is placed at the tip end of co-axial cable test prod, in-

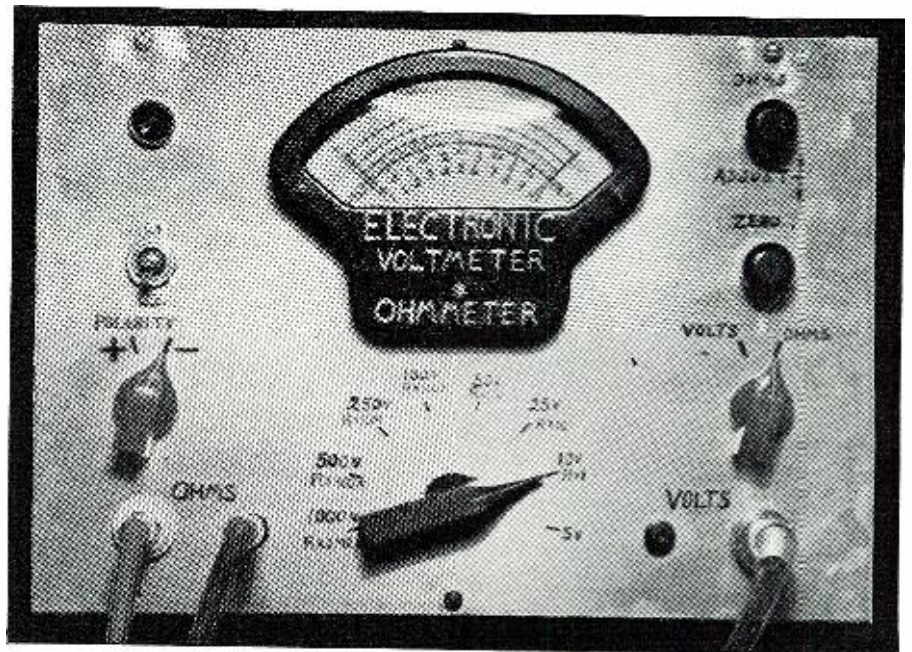

Panel layout of the serviceman's electronic volt-ohmmeter.

by **NORMAN E. NELSON**

Mayville, North Dakota.

This unit as a volt-meter will measure up to 1000 v.; as ohmmeter, 1000 megohms.

side the prod. The cable is placed as far up within the prod as possible. Be sure to use a high quality test prod. The voltmeter section is indeed a wonder to test with as all grid, avc, afc and any voltages that appear across high resistance circuits can all be tested at their true operating values; and better yet, no matter how critical the grid voltage might be, this meter will check it and *without affecting the operation of the radio in any way*. Oscillator voltages can be checked perfectly; and to top this, the oscillator dead spots can be checked over all bands merely by placing voltage test prod on the oscillator grid and noting the voltage indication over entire dial. All d.c. voltages in the audio section of a radio can be checked, and at their actual operating values. Furthermore, the voltmeter section together with a good signal generator, calibrated in microvolts, will make a very versatile means of "Signal Tracing."

Constructional Details:

I built up the original layout on a breadboard in order to facilitate the changing of components until all values were derived. This saved a lot of time. If the instructions are followed this will not be necessary, except in the case of the voltmeter voltage divider network, should you desire to use ordinary resistors as I have used in mine. I will give the values of ones I

used which will be of some help in calibration, and then too I shall also state the approximate values to use should you desire to use precision resistors.

First the front panel is constructed. The panel is aluminum. After drilling and reaming all holes, use a mixture of lubricating oil and fine pumice stone and rub down panel so as to obtain a very smooth satin-like finish. Rub very lightly back and forth across the panel but not up or in a rotating movement. Use plenty of oil as this will make a nicer finish. Next make a sub-panel size 4½" by 9" out of ½" or 3/16" bakelite. Mount this up against lower back of meter or just an inch back of panel. Mount the three tube sockets in center back of meter.

Before mounting the subpanel mount all the controls, meter, bracket light, a.c. switch, pin tip jacks, ceramic ohms output jack and the *Amphenol* chassis connector all on the front panel. To mount the subpanel, solder an angle bracket onto the rear cover of zero adjust control for the one side and on the other make a twist bracket and mount it back onto the polarity switch S3. Next proceed with the wiring.

For all wiring I have used *Belden's* No. 8841 r.f. hook-up wire as it has a very high insulation resistance and a puncturing voltage of 3800v. at 60 cycles. First wire in the filament supply connecting the pilot lamp, fuses

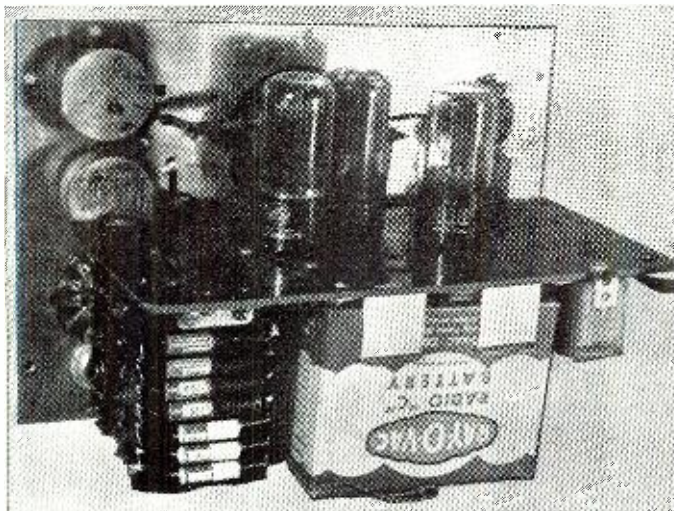

Rear view of the electronic unit.

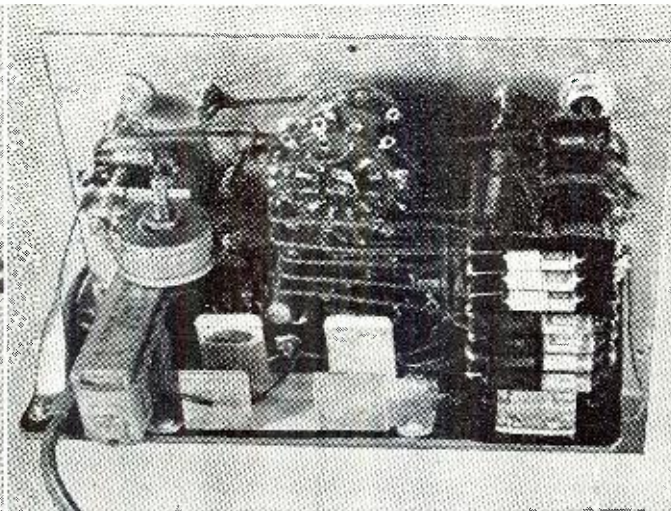

Under chassis view of the volt-ohmmeter.

and a.c. switch. Next wire in the power supply, placing the resistors as neatly as possible near the sockets and using the unused socket terminals as tie terminals.

Place the filter capacitor block "C1 & C2," in back of polarity switch S3 below subpanel and mount the calibration-adjust control just below this capacitor by means of a bracket to the rear of polarity switch S3. Connect leads 1 to 6 from volts-ohms switch, S2, to their respective places as per schematic. Next connect resistors and leads to switch S3. Then place all the resistors for voltmeter network on three high quality bakelite strips approximately 1½" by 3". Wire all these resistors in series and then mount strips vertically in back of volt-ohms switch S2 by means of small angle brackets, and wire them to their respective positions on the center gang range switch S4, on the switch section next to panel. You will note that I have wired the voltage and ohms ranges increasing counter-clockwise. This can be wired the opposite way just as well; only be sure to wire so that both run together.

The 5 volt range is number one and the number one tap on the ohms circuit goes to chassis ground so as to keep meter needle from going off scale on this ohms tap. After completing wiring voltage ranges proceed with making a 2" by 3" bakelite mounting strip for the ohms ranges resistors. In mounting all these and the volts network resistors too, I used a 1/16" drill and made holes at each outer end of resistors and brought resistor leads through holes and then joined them. Mount all ohms range resistors

in place and join them all on one side.

Mount this in place back of volts resistor strips, and wire in each resistor to the back gang switch S4 section. Wire in leads from taps 7, 8, and 9 of switch S2; number 7 going to ohms jack J1 and the common of section No. 2 of switch S4; and number 8 to the grid of V2 in series with two megohm resistor R37; and number 9 going to common of section No. 1 of switch S4. Connect lead from 5 volt tap to *Amphenol* No. 80-C jack J2.

In doing all the wiring, you will note that all leads to switches and resistor networks are made in neat ladder formations with square corners, and in no way are any twisted leads or cable wiring allowed. Due to the extreme sensitivity of this instrument, the latter type of wiring would add to the capacity and naturally cause trouble. Another tip is to be sure to run a jumper lead across both ground tip

jacks and thence a bus back to all ground leads. Also make very good soldered joints, and under no circumstances use any flux in soldering leads to switches and resistor strips. Make a spring type clamp so as to mount the 4½ volt C battery upside down beneath panel.

To make the numerals on the front panel I've used a regular pen point and red and black enamel. The photo will show all the lettering. The ohms ranges are in red and the volts black and all others in black too. I've also printed "ELECTRONIC VOLTME-TER-OHMMETER" on the lower front of the meter with white refrigerator lacquer.

To calibrate the meter,—proceed as follows: Remove front cover from meter and then remove meter scale. Remove the paper dial from the brass dial scale by using a knife-blade. Cut

(Continued on page 55)

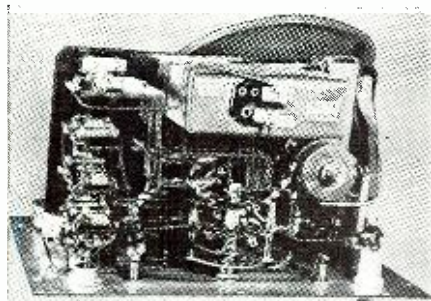
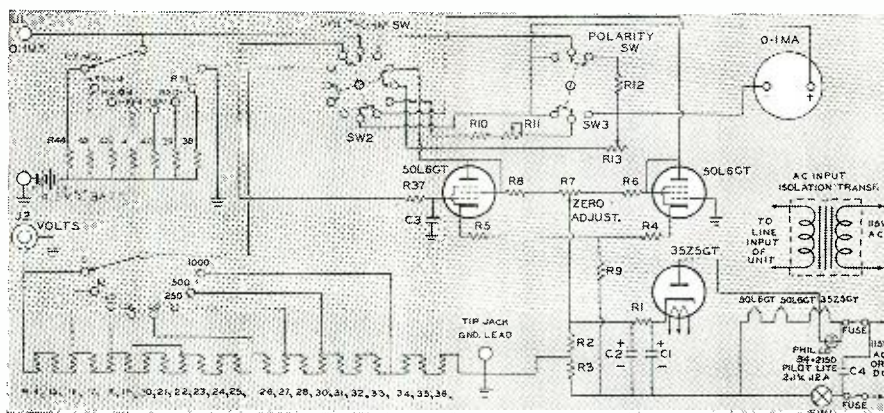

Another under chassis view.

R₁—1250 ohms, 10 w. Ohmite
 R₂—16,000 ohms, 1 w. IRC
 R₃—23,000 ohms, 1 w. IRC
 R₄—R₅—1,000 ohms, ½ w. IRC
 R₆—R₇—4,000 ohms, 1 w. IRC
 R₈—5,000 ohms pot. Mallory
 R₉—15,000 ohms, 1 w. IRC
 R₁₀—2,000 ohms, ½ w. IRC
 R₁₁—3,000 ohms pot. Mallory
 R₁₂—100 ohms, 1 w. IRC
 R₁₃—5,000 ohms pot. Mallory
 R₁₄—R₁₅—5 megohms, ½ w. IRC
 R₁₆—3 megohms, ½ w. IRC
 R₁₇—R₂₀—500,000 ohms, ½ w. IRC
 R₁₈—R₁₉—250,000 ohms, ½ w. IRC
 R₂₀—400,000 ohms, ½ w. IRC
 R₂₁—1 megohm, ½ w. IRC
 R₂₂—50,000 ohms, 1 w. IRC
 R₂₃—750,000 ohms, 1 w. IRC
 R₂₄—R₂₅—100,000 ohms, 1 w. IRC
 R₂₅, R₂₆, R₂₇—25,000 ohms, 1 w. IRC

R₂₇—R₂₈—75,000 ohms, 1 w. IRC
 R₂₉—60,000 ohms, 1 w. IRC
 R₃₀—6,000 ohms, 1 w. IRC
 R₃₁—2,500 ohms, 1 w. IRC
 R₃₂—55,000 ohms, 1 w. IRC
 R₃₃—2 megohms, ½ w. IRC
 R₃₄—10 ohm, 1 w. IRC
 R₃₅—100 ohm, 1 w. IRC
 R₃₆—1,000 ohms, 1 w. IRC
 R₃₇—10,000 ohms precision. Continental
 R₃₈—100,000 ohms precision. Continental
 R₃₉—1 megohm, precision. Continental
 R₄₀—10 megohms, precision. Continental
 C₁—C₂—8-8 mfd. 250 v. electro. Mallory
 C₃—0.01 mfd. mica. Mallory
 C₄—0.5 mfd. 600 v. paper. Mallory
 M₁—0-1 DCMA. Beede
 S₁—SPST Toggle. Bud
 S₂—#1450 Centralab.
 S₃—#1462 Centralab.
 S₄—#1321L Mallory

Serviceman's Experiences

by LEE SHELDON

Chicago, Illinois

One good old-time big radio set is worth several times as much as a mess of midgets. Any serviceman can check on this.

"T'S not often I pick up four repair jobs from four calls, so I looked forward to a pleasant word of commendation from my partner when I arrived at the shop. Of course, it would have been much easier to carry the four midgets in two trips from the truck to the door, but a single trip, with a set in each hand and one under each arm, was much more dramatic.

Al wasn't in the front of the store, so I had to kick the bottom of the door. Nothing happened. Gosh, but my hands got cold! I made up my mind to move out to San Francisco if I ever got the chance. Fog or no fog, the west coast would be better than Chicago, where nor'westers sweep in across Lake Michigan. I kicked again, and Al finally came to the front of the store and let me in.

"You have strong feet," he remarked as he opened the door. "I wish I could say the same about your other end!"

Through long association, I have become inured to my partner's cheap jibes. Instead of answering, I proudly laid the four sets in panorama on the counter and turned to him for some appreciation.

"One," I prompted, "two, three, four. Not bad, eh?"

"Where's the fifth?" Al asked. "When you left the shop you had five calls. What happened to the big *Bosch*?"

"Oh, that," I explained, "went down to the bottom of my list because it would have taken so long to get the chassis from the cabinet. Instead, I got these sets first. Aren't four better than one?"

"Not if they're midgets," Al replied. "Look, Mr. Legree," I said. "To a certain extent, I sympathize with your favoring old sets because you associate them with the prices we used to get. But that was ten years ago, and since then the midget has come to stay. Whether or not you like midgets, they are an important part of today's business!"

"I'd rather have that one *Bosch* than all these midgets put together," Al grumbled, with rising pressure.

"Foolishness," I replied. "I wouldn't be back yet if I'd called there first. Besides, I'll bet there was nothing wrong with the set but a gassy 80. We're better off as things stand now, with four sets to work on."

"Four *headaches*," Al insisted, warming up. "There are a lot of reasons that I don't like small sets. In making most of them, cost was the prime design consideration, and that one factor introduces a bunch of tricky technical problems. The repairman usually finds himself giving more of his talent and time on them. Another bad feature is their compactness; as a result of it, the repairman—"

I know better than to interrupt my partner when he hits his stride. He was entirely wrong, of course, but instead of trying to argue with him, I sat down with a great show of weariness. From this, Al inferred I was reconciled to defeat; he paused at my movement, and resumed with more vigor.

"—the repairman finds himself with a chassis smaller than the soldering iron he uses to fix it. He also must remove components so tiny they must have been originally installed with an unethical use of the fourth dimension. Then, after the trouble is finally isolated, the replacement part sometimes costs twice as much as one of standard size. If it's a tube, it's probably a special one he has to wait ten days for while he orders it from a distributor in Seattle."

"Did anyone ever tell you you were beautiful?" I asked, rapidly blinking both eyes.

"The customer rarely thinks as much of a small set as of a big one, so it's harder to get a decent price for our work. The customer believes—and we can't blame him—that a big set requires the most labor, and that makes it even tougher for us to make a quotation on a small set sound legitimate."

"For the first time," I interrupted, raising my head from my hand, "I see you as you really are. As you walk to and fro, I can't help but notice the highlights on your brown hair are lovely!"

"Then, if we *do* manage to get the job," Al continued, "the customer is never as satisfied as he would be if we'd spent half the time on a large set. From the beginning, the customer has sensed our unwillingness to analyze the trouble in his home, and believes we remove the set to the shop only to pretend a minor repair is a major one. If he's paid ten dollars for the set, he gets mad if you charge five

for repairing it—and madder still if we try to sell him a new one for twenty. The net result in customer satisfaction is likely to be nil for this reason; and as far as profit is concerned, the serviceman often finds, after repairing ten midgets, that he has to sue himself to break even."

"I like the cute way you wiggle your ears when you get mad," I said, softly.

"We may look down on the big old consoles and combinations as being beneath our dignity," Al continued, "but they still are the salt of the repair business. Through long practice, we know how to analyze their faults; and if we come across a new one, the wiring is open and their parts are easily accessible. Replacements are standard items which have been on the market year after year; we know exactly how long it takes to get them, how much they cost, and that there are many close sources of supply. The mechanical work is much easier. The customer doesn't try to call back the owner of the store where he bought the set, so—as far as a serviceman is concerned—the repair work is in the public domain."

"Don't you ever feel, dear," I asked with an alluring smile, "that you'd like to get away from it all? Can't we slip away to my little place in Gnaw Bone, Indiana?"

"You made a mistake when you didn't go after that *Bosch* first," Al said. "These midgets only clutter up the place!"

"Well, what are you driving at?" I asked, kicking Cupid into the corner. "Want me to give them up altogether?"

"That's not what I meant," Al replied. "But after this, if you get a choice between a big old set and some little new ones, *get the big one first*. Now, go get that *Bosch*—and bring back four aspirins!"

"Okay, okay," I agreed, "but I'll bet there's nothing wrong with it. It's in a new apartment house, and the owner probably wants an antenna plug!"

As it turned out, the customer had moved in from a d-c neighborhood, and we got a juicy conversion job. When I tried to sell him a new set, he admitted the chassis was old, but said he had to keep it because his wife couldn't bear the thought of giving up the beautiful wood-work on the old cabinet.

Al got a lot of satisfaction from the fact we made twice as much profit from the *Bosch* as we made from the four midgets; but I still believe a serviceman should get just as much for a given amount of labor on either a large set or a small one.

"Sure he should," Al agrees, "but how many of us *do*? We're such poor

(Continued on page 59)



THE "PRAIRIE DOG" SPECIAL TRANSMITTER

by Raymond Frank, W9JU

UT of the welter of new regulation designed to make the air safer for the U. S. Gov't, to discourage 5th-columnists and other fascist and foreign agents, there remains the Field Day and the testing of portable equipment for the amateur. These two outlets have been left to the ham whose pleasure it is to drive to out-of-the-way places and send his call letters winging through the ether.

Of the many types of equipment described in RADIO NEWS and elsewhere, probably none has stood the test of actual use as much as the rigs built up by the organization known as the *Prairie Dogs*. Organized in Chicago informally about three years ago, the group grew until it now numbers over twenty members. Its official existence started a year ago, and for their last score, the *P. D.* group stood 1st in the 4-transmitter group in the 1940 Field Day, and 2nd for all non-club groups. That's a nice record, and the *Prairie Dogs* attribute it to their rigs, which are all more or less the same, and which will be described herein.

The unit shown is capable of operation on all bands from 160 to 10 Meters, phone and c. w., and will work either from 115 volts a.c. or a 6 volt

storage battery. Although 10 Meter operation is not particularly useful for emergency work, it was nevertheless included for whatever use it might be. Power input to the final on a.c. runs about 24 watts on phone, and 35 watts on c. w.; and on battery, 12 to 15 watts on phone and 20 watts on c. w. The input on battery is limited by the capacity of the vibrator. By using an *Electronic No. 490* vibrator, heavy duty type, the input can be the same on a.c. or battery. If this vibrator is used, it will be necessary to change C13 to .1 mfd.

Construction

The entire unit is constructed on a 7"x12"x3" chassis and mounted in a *Par-Metal* deluxe cabinet using an 8"x14" front panel. Careful planning is necessary to get all of the parts in the available space. The coil assemblies are regular manufactured units made by *Barker & Williamson*. The socket for the *HY60* is mounted below the chassis by means of pillars, permitting the use of an *HY61* or an *RCA807*, if desired. Tube choice is rather flexible, and a 6L6 or 6F6 may be used as an oscillator in place of the 6V6G. The audio can be a 6J5 and the

modulator a 6L6. Mike voltage is obtained by means of a slider on the cathode resistor of the modulator. The modulation choke is a universal-tube-to-speaker transformer with the secondary unused. Four crystal sockets are mounted on the chassis and the fifth on the panel to permit using any crystal available. A.c. and battery leads are brought to the four-prong socket mounted on the rear edge of the chassis, together with a fuse and a five-prong socket, which is wired to permit using the power from the transmitter on other equipment, if desired.

Controls

In the upper-left corner of the panel is a pilot light connected across the heaters to indicate whether the transmitter is off or on. Slightly below and to the right is the coil switch for the oscillator. Directly under the meter is located the a.c.-d.c. switch and to the right of this is the coil switch for the final. In the upper right corner the antenna current indicator and the two antenna posts are located. Directly below the antenna posts is the antenna switch. The left edge of the panel contains the crystal socket for external crystals; below it the

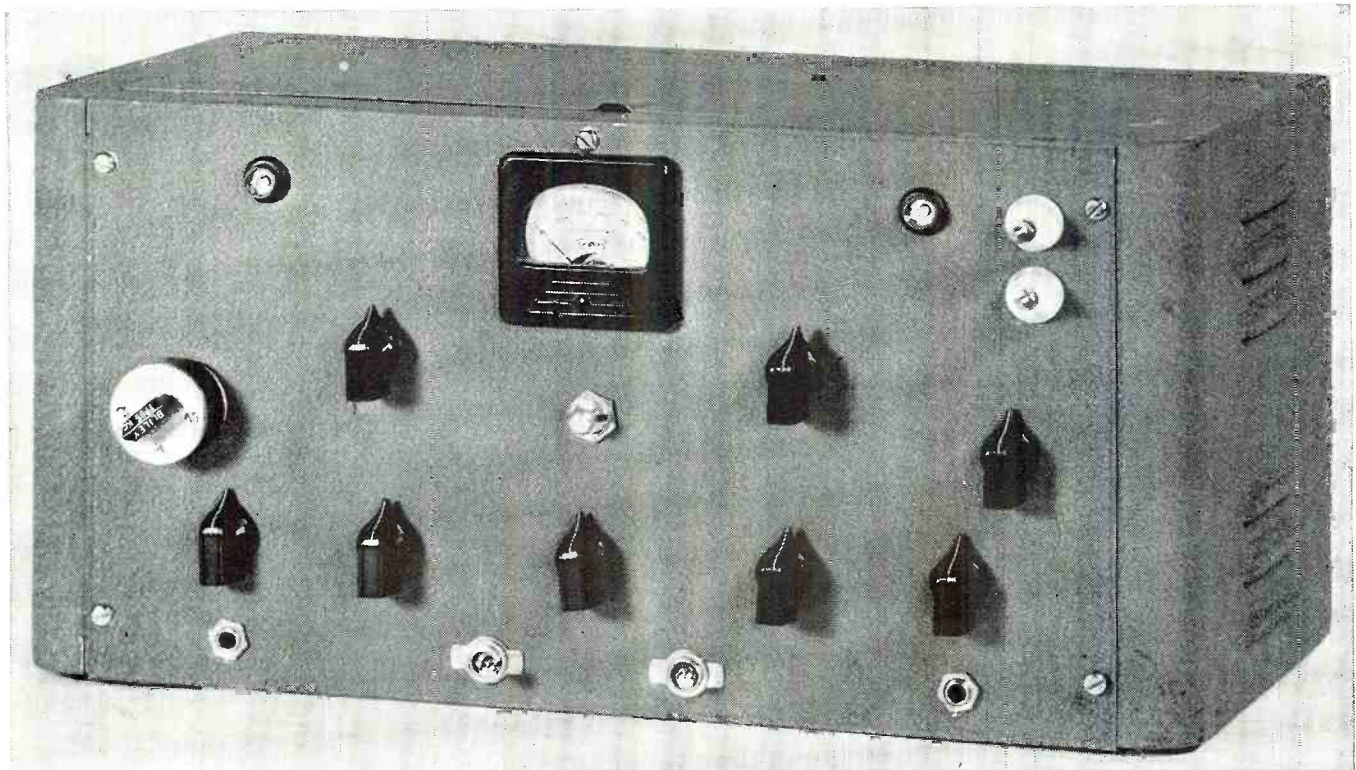

This little transmitter has been built in quantity lots by an energetic Field Day Group. Amateurs will find it versatile, easy to build and use.



Notice how compactly the transmitter is laid out.

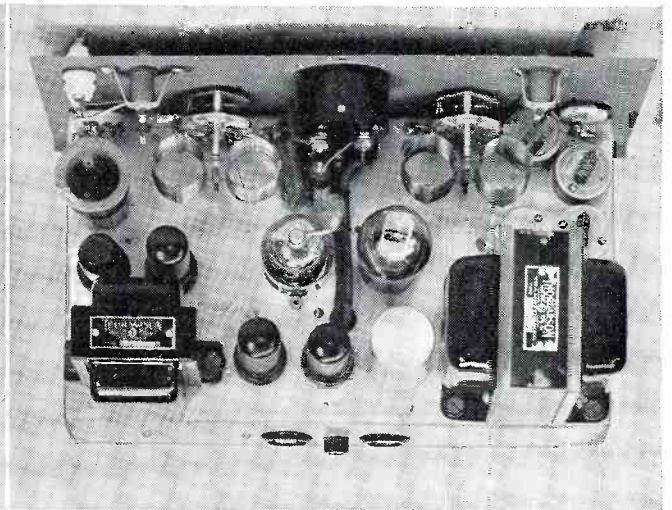

This will give an idea where the parts are placed.

crystal switch, and to the right of the crystal switch is the oscillator tuning condenser. Below the a.c.-d.c. switch is the final tuning condenser and below the final band switch the antenna tuning condenser. The gain control is mounted below the antenna switch. Along the lower edge is mounted the key jack and stand-by switch and phone c. w. switch and the microphone jack.

Switch No. 3, the a.c.-d.c. switch, is a DPDT made by *Cutler-Hammer*, and switch No. 4, the stand-by switch, is a DPST switch also by *Cutler-Hammer*. Both of these switches are of the heavy-duty type capable of carrying 15 amps. Switch No. 2 turns off the audio section, thereby conserving power when c. w. is used.

Circuit

The oscillator is of the harmonic type and permits operation on two bands with one crystal. Doubling may also be accomplished in the final with

little drop in output, thereby permitting operation on three bands with one crystal. Keying is in the oscillator cathode, permitting break-in operation essential for emergency work. The oscillator is coupled to the final through a mica compression padder to permit adjustment of the drive. 50 ohm resistors in the grid and plate leads, of the *HY-60*, prevent parasitic oscillations common to beam power tubes. The 0-100 ma. *Triplet* meter in the plate of the final indicates the loading.

Testing

When trying the unit for the first time, condenser C1 should be carefully adjusted to give the greatest output consistent with minimum current as indicated by the 150 ma. pilot bulb in series with the crystal. Resonance is indicated by a rise in the plate current of the final. With an antenna connected to the transmitter and coil L3 shorted out, condensers C10 and C11 should be varied to get the greatest

antenna current as indicated by the bulb in series with the antenna. The size bulb needed is determined by the antenna impedance at the terminal. Usually either a 200 or 400 ma. size will do. Loading as indicated by the milliammeter should be carefully watched as condensers C10 and C11 are varied and a point will be found that gives the greatest output with the minimum loading. If it is not possible to obtain sufficient loading, the antenna coil should be cut in, one tap at a time, until the optimum point is found. With this antenna tuning method, it is possible to load any length of wire. With the modulation switch, SW2, on, speaking into the microphone should cause a rise in antenna current as indicated by the antenna bulb.

Conclusion

The actual construction should only be undertaken by an experienced amateur or a professional radio operator. While there is nothing very tricky

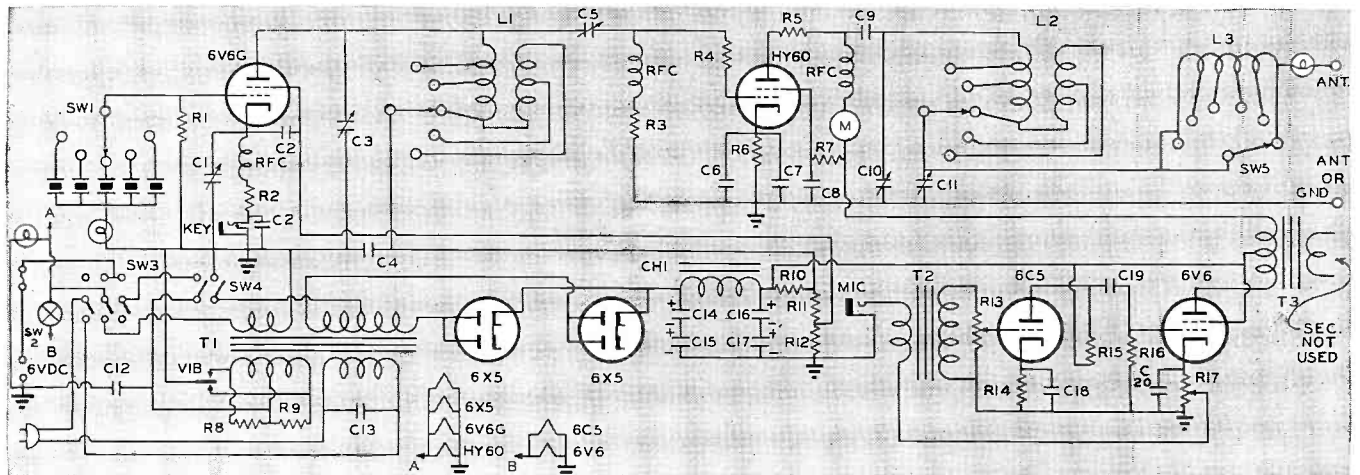

- C₁—500 mmf. mica padder. Hammarlund.
- C₂, C₃, C₇, C₁₀—.006 mica. Aerovox.
- C₄—100 mmf. variable. Bud MC 905.
- C₅—10-70 mica padder. Hammarlund.
- C₆—10 mfd. 50 v. electro. Aerovox.
- C₈—.003 mica. Aerovox.
- C₉—.006 mica 1,000 v. Aerovox.
- C₁₀—140 mmf. variable. Bud MC 906.
- C₁₁—325 mmf. variable. Bud MC 910.
- C₁₂—.5 mf. 200 v. paper. Aerovox.
- C₁₃—.06 mf. 1600 v. paper. Aerovox.
- C₁₄, C₁₅—12 mf. 450 v. electro. Aerovox.
- C₁₆, C₁₇—16 mf. 450 v. electro. Aerovox.
- C₁₈, C₂₀—10 mf. 50 v. electro. Aerovox.
- R₁, R₁₅—500,000 ohms, 1/2 w. Aerovox.

- R₂—300 ohms, 1 w. Aerovox.
- R₃—10,000 ohms, 1/2 w. Aerovox.
- R₄, R₅—50 ohms, 1/2 w. Aerovox.
- R₆—350 ohms, 10 w. Ohmite.
- R₇—20,000 ohms, 10 w. Ohmite.
- R₈, R₉—100 ohms, 1/2 w. Aerovox.
- R₁₀—3,000 ohms, 10 w. Ohmite.
- R₁₁, R₁₂—25,000 ohms, 10 w. Ohmite.
- R₁₃—250,000 ohms, variable type M. Yaxley.
- R₁₄—3,500 ohms, 1/2 w. Aerovox.
- R₁₆—500,000 ohms, 1/2 w. Aerovox.
- R₁₇—400 ohms, 10 w., semi-variable. Ohmite.
- T₁—350-0.350 v. @ 135MA., 6.3 v. @ 4.75A., 6 v. or 115 v. pri. T14R40 Thordarson.
- T₂—S.B. mike-to-grid. T86A02 Thordarson.

- T₃—Universal tube-to-voice-coil. T57S01 Thordarson.
- Ch₁—12 Hy. 150MA. T17C00B Thordarson.
- SW₁, SW₂—12 pos. tap switch. 32112J Yaxley.
- SW₃—SPST toggle switch. Cutler Hammer.
- SW₄—T.P.D.T. heavy duty. Cutler Hammer.
- SW₅—Double pole, single throw heavy duty. Cutler Hammer.
- L₁, L₂—“Bandhopper” 2A. Barker & Williamson.
- L₃—50 turns #24 P.E. close wound on Hammarlund 1 1/2" coil form, tapped every 10 turns.
- L₄—2.5 M.H. 125 M.A.
- M—0-100MA Model 221 Triplet.
- Vibrator—825 or 294 Mallory.
- Cabinet—Par Metal De Luxe No. CA202.

AVIATION RADIO

by CHARLES J. SCHAUERS

about this, the matter of short leads, and the best manner in which to interconnect the various components is something that cannot be described in full, and the only substitute for that description is—experience. A beginner can attempt the construction, if he will go slowly and *think* before each connection is made.

Since quarters are very cramped, it is almost necessary to follow the illustration of the top of the chassis in laying out the parts, exactly. Slight changes in layout to permit the individual tastes of the builder to be satisfied can be tolerated, but no guarantee can be made that the unit which deviates from the P.D. Special will perform as well as the originals.

A word about operation. The FCC regs specifically provide that portable operation can only be done on the week-end and then only on 48 hour's notice to the Commission's nearest office to your home QTH. Besides this the law provides that the transmissions *MUST* be from portable power sources. These are batteries, or some generator or another. The use of 115 v a.c. house lines even if they be strung out into a field is specifically prohibited; though a motor generator producing this voltage is not. So use your P.D. Special only on 115 v a.c. at home, or if in the field, then only from some motor-generator or battery. The pro-



Notice the shield (arrow) around the oscillator tank condenser. It should be included in your model. Short-lead wiring must be observed.

visions concerning reception are left open, and there is not any requirement that the receiver be battery or motor-generator powered.

The amount of DX workable with the small power available will be directly reflected in the type of antenna used. Do not skimp on this end of the rig. A good antenna, soldered to size at home, carefully wrapped over sticks or on a roll, strung high between trees or poles, is half the fun and half the way towards working some real dx. A small 20-watter consistently worked Texas from a picnic grove in Illinois with such an antenna, right through the Sunday morning QRM on 20 meters. You can do likewise if you will but make the effort.

Finally there is the National Defense and QRR angle. If there will be many more of the ham fraternity who will build up similar sets, then not only will there be a step in the right direction of standardization; but any other ham, unfamiliar as he might be with your particular rig, will be able to operate it on short instruction because he, too, might have a similar transmitter at home.

-30-

Aviation Radio Frequencies

THERE seems to exist some doubt concerning aircraft frequencies, especially 3105, and 6210 kilocycles.

On August 1, 1939, the *Federal Communications Commission* lifted the "ban" on 6210 kilocycles as a "day only frequency." Both 3105 kilocycles and 6210 kilocycles may be employed both day and night by aircraft for contact with ground stations. However, 3105, a "distress" frequency should alternatively be used with 6210 for good consistent communication.

Although transmitters in many privately owned airplanes are capable of transmitting not only 3105 kc. but also on 6210 kc., yet it seems that very few pilots use 6210 kc. at all. Most pilots attempt to maintain communication at 3105 kc., and if they are unsuccessful in doing this, they decide that they are out of range of the station which they are calling. Actually, during daytime flights, a pilot will usually find it best to use 3105 kc. for communication to points out as far as the end of the 6210 kc., skip distance. From that point on, 6210 kc. will usually give reliable communication out beyond the receiving range of the receiver which they are using. This information passed on to pilots by the aircraft radio technician will be appreciated by them, because many of them do not readily understand the "range-ability" of their sets, even though they use them every day.

General

LAST month, the writer had occasion to visit numerous "aircraft" radio service shops located on the West Coast, principally near Los Angeles; and he found many interesting features incorporated in each and every one of them.

One service shop employs a traveling "aircraft super-test stand." This stand can be wheeled out to an aircraft and will test an entire radio installation. . . . The unit contains drawers containing assorted nuts, bolts, washers, tubes, wire, shielding material, etc., and it can be said that this particular serviceman has forgotten the story of the plumber who always went to a job and arrived on the scene minus everything needed for an efficient repair or installation job.

Aircraft radio installation men working in aircraft factories on the Coast are working overtime in order to hold up their end of the immense task of putting defense aircraft into commission.

Reports from the East Coast indicate an intensive activity in the aircraft radio industry; both manufacturing and installation branches are "hard at it" making up, for "no lost time."

Many questions (more questions) have been received by the writer and a number of them pertained to the same question, i.e., "How do I get started in the aircraft radio service business; what do I need; where do I get it?" This question will be answered next month.

Bonding and Shielding the Aircraft

IGNITION interference in aircraft radio receivers has always been a major problem, even though some aircraft are bonded and shielded at the factory. Due to vibration, bonding connections, and shielding connections are vibrated loose, and this not only adds another source of interference but increases the interference from radiating members of the ignition system.

Roughly, ignition interference may be classified into two classes: 1. Radiated interference, that interference emanating from the aircraft's electrical system or metal supporting frames or the fuselage of the aircraft itself; 2. Conducted interference, that interference that reaches the aircraft radio receiver through the aircraft's central power

system (battery, connecting cables, control boxes, etc.).

Radiated interference is usually curbed if the offending members of the aircraft, especially those situated near the engine, are shielded and grounded. . . .

Conducted interference is usually always curbed by making the entire aircraft (those of metal construction) using any point as a reference to another point along any metal surface, "one" conductor. That is, by using a low range ohmmeter and measuring from any point of metal contact to any other point on the aircraft, the maximum resistance should be in the order of .001 to .004 ohms.

Each cable connecting radio apparatus should be adequately shielded and bonded along its entire length and taped, then coated with shellac. After this is done, bonding strips soldered to the cable's shield before taping, should be grounded.

If, after checking the shielding and bonding, it seems to be all right, the next step for the elimination of conducted interference would be to install choke coils in series with the ship's battery supply cables.

Interference from rubbing metal members can be eliminated by connecting each member to a central one with bonding strips, this also lowers the resistance, which is very desirable in "one wire systems."

More information on shielding and bonding the aircraft will be given next month.



An electron controlled radio-compass.

Kink of the Month

THE telephone "Kord-Kurler" found in most five and ten stores makes a swell headphone cord "unraveler" and microphone cord "compressor."

Fasten the "Kord-Kurler" to the cord, starting about ten inches from the outlet—this will allow room for slack and prevent the cord from tangling with the "Kurler" or the pilot's or radio operator's "manual freedom."

From the Mail Box

JOSEPH R. MANNING wants to know what my definition of "safety factor" is. Well, Joe, the term "safety factor" as applied to aeronautics is a term which most people do not seem to grasp in the correct light.

My definition of it takes into being the safety of aircraft in the air which is what everyone connected with aviation usually strives for. Those contributing factors, such as better radio equipment, more trained per-

(Continued on page 63)

MAINTENANCE

by **W. H. BOHLKE**

Director of Test Equipment Merchandising, R.C.A. Mfg. Co., Camden, N. J.

Completing the service bench with an audio oscillator and an oscillograph.

Part 4.

LET'S look at the audio end of this maintenance business. What do we find? We find many audio frequency systems of varied type and varied application. In the normal broadcast field, the audio amplifier of the home receiver is one which is supposed to operate over an audio range of from about 30 cycles to about 5000 cycles. In some instances, those wherein what is called high fidelity reproduction is anticipated, the frequency range is extended to about 10000 cycles at the high end and the low remains "as is." However, it is also true that many millions of receivers employed in the home, those receivers known as "midgets," do not amplify the lower end of the normal audio band. The design of the audio amplifier is such as to minimize amplification below 120 to 200 cycles; and the speaker, because of its size, contributes further to the suppression of the lower audio range. But if we take this field as a whole from the viewpoint of testing, it is essential that an audio test signal source capable of producing audio voltages from about 30 cycles to well over 10000 cycles is needed.

In the auto radio field, which we may place within the home receiver category without creating much confusion, we find a condition that very much parallels that existing in the home, so that from the viewpoint of servicing audio systems in the auto radio receivers, that which is suitable for home receivers is suitable for auto-radio receivers.

In the aircraft field, as it applies to

both receivers and transmitters, a somewhat different situation prevails. The requirements of such instruments are entirely devoid of high fidelity response. Since the nature of the transmission in such systems is speech only and never music, unless the transmission from one of the regular broadcast stations is used as a means of maintaining direction of flight towards the home airport, in which case the magnitude of distortion in the music is of no importance, the usual design of what audio system is such that a spread from 3000 to 4000 cycles is as much as is necessary. In fact, in some of the beacon receivers, the selectivity of the tuned circuits ahead of the audio system very materially reduces the level of the sidebands to as low as 3 kc. each side of the carrier. Thus whatever the requirements of the audio systems in aircraft receivers, they are entirely within the rated audio range of 30 to say 15000 cycles.

As to the portable receivers which are offered to the private aircraft field as "homing" units operated with a simple loop and intended for the reception of broadcast stations, the design of the audio system does not entail any special features which would tend to place such audio requirements beyond the capabilities of the basic audio signal source which we have mentioned.

In police systems we have a similar condition, as can well be appreciated if you have ever listened to speech as received over a police receiver. This by no means is intended as criticism of the design of such systems, for

after all, there is no need for high fidelity. All that is needed, as in the case of aircraft units, is communications with freedom from interference and this can best be accomplished by utilizing maximum selectivity in the tuned circuits of the receiver. Whether cut-off takes place at 3000 cycles or 4000 cycles is of no consequence. It can just as well take place at 2000 cycles without in any way interfering with the intelligibility of the speech. In this connection it might be of interest to mention in passing, that the writer—on his own—carried out some experiments in "ham" radio, utilizing band pass filters which passed a maximum of 1500 cycles and in many instances, such major limitation in the width of the transmitted sidebands, greatly aided the completion of contacts.

So the police system, like the others mentioned, comes within the scope of the suggested audio signal source.

How about those systems known as public address and sound re-enforcement? As a general rule most people consider them one and the same. In fact we, too, felt that way until further investigation seems to bring to light some differences. Not that it makes much difference in the final analysis, but if there are some differences, let's look at them. You don't have to agree. The public address system, according to some, is intended for the magnification of speech sounds and whatever arrangements are used to amplify these sounds are usually constructed so that proper correction for speech sound conditions can be effected. This means that the normal audio range usually identified with the amplification of music is not utilized. In the sound re-enforcing systems, where both speech and music frequencies are amplified, the frequency response is much greater.

All of this may be so to those who draw such a fine line of demarcation, but in our opinion, both systems are alike, although it is true that in those systems which are intended specifically for speech amplification, there may be a greater abundance of corrective networks so as to accommodate, not only the location, but even the characteristics of speech sounds of the speaker, with the ultimate pur-

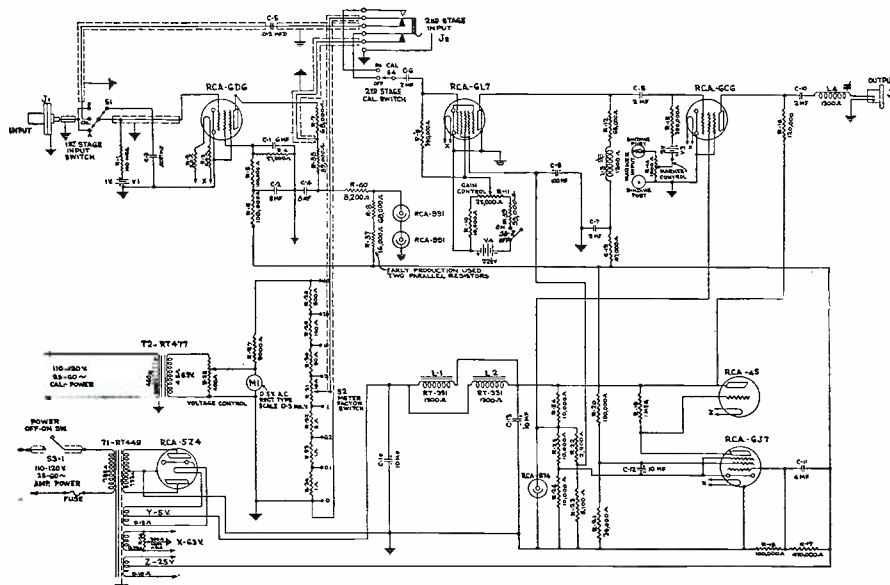

Fig. 2. Special amplifier's circuit diagram.

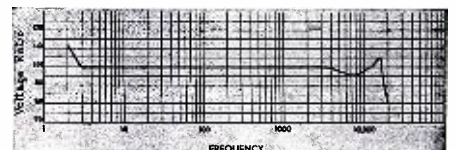
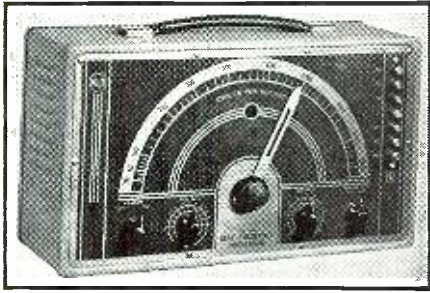

Fig. 1. Amplifier frequency response.



The audio oscillator.



The 5 inch oscillograph.

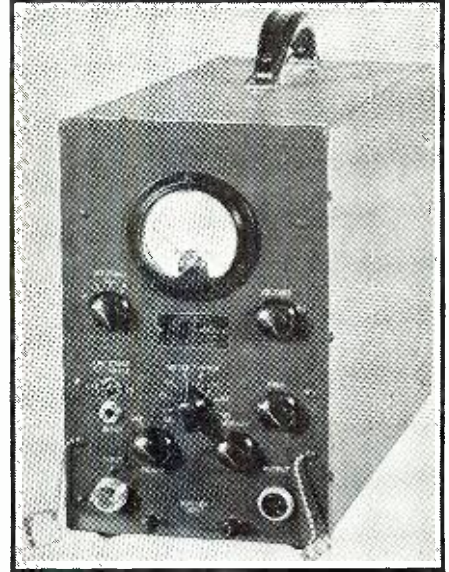

The special amplifier.

pose of making his or her voice sound most pleasing to the listeners. This, we would agree, is a refinement,—perhaps a necessity. It all depends how you view the subject. Be that as it may, the fact nevertheless remains that when considering public address systems, we must take as the criterion that which requires the broadcast range of frequencies, for then we include whatever narrower band may be required by other apparatus. So, at least for the present, we find no reason for expanding our study beyond the 30 to 15000 cycle band.

In industry (and this division of electronic activity is daily increasing in importance), we find a somewhat different situation. Audio work in this case is not the amplification of frequencies for the purpose of reproduction of speech or music. If it were, it would come within the category of public address or sound re-enforcement, whichever you may wish to call it. Instead, there are such things as vibration testing of moving devices, (gears, motor bearings, crankshafts, floors, chairs, fixtures, etc.). For the moment, we must admit that such operations seem far removed from the activity of the service shop, but is that any reason why it must be forever in the future? Particularly when such operations are multiplying in industry and someone must be capable of applying apparatus of this kind or servicing apparatus of this nature, if already in the possession of the plant.

In work of this character, that is, repair of such apparatus, two differences with respect to the encountered audio frequencies is experienced. In the first place amplifiers of the variety suitable for application to vibration tests must be capable of passing the very low frequencies—frequencies as low as 0.2 cycle per second. This, we appreciate, is far different from the types of audio amplifiers familiar to the normal radio servicing industry. In fact, a response curve of the type shown in *Fig. 1* is in itself a strange creature—at least that portion of the curve below 30 cycles. The rising characteristic between 2 cycles and

about 1.25 cycles is most certainly a peculiarity in normal audio work. Second, at the high end, a peak exists at 15000 cycles with plenty of amplification at 20000 cycles. If you don't believe that such an amplifier exists, you'll find the schematic in *Fig. 2*. True, it does not look very much like the usual amplifier, but then it does work and many are used daily.

Amplifiers of this variety, which are capable of passing such low frequencies are the equivalent of amplifiers which will pass square waves with very little distortion and naturally *sine* waves in like manner. But the servicing of such apparatus is a little bit different than that of the conventional amplifier, in that a source of low frequencies as is represented by the lower limit of amplification possible with this system, is necessary. Actually, the mention of this apparatus is not with the view of speaking about the maintenance of such equipment, but instead, the type of apparatus which will eventually come within the province of what we classify as a *communication and electronic maintenance organization*. Such amplifiers are used with special crystal pick-ups as well as oscillographs. Incidentally, we shall speak about oscillographs later in this article, but in the meantime, it is interesting to note that the usual crystal pick-up used in a phono-

graph tone arm is suitable for use as a vibration pick-up device. Of course, the true character of the vibration impulse will not be noted upon an oscillograph after amplification, unless the amplifier has the proper response, but for experimental purposes, if you are so inclined, you can try what you have.

In line with industrial application of electronic apparatus are those which are suitable for the measurement of noise. To speak about such devices at this time is digressing from our discussion of a signal source for checking audio systems, but in much industrial work we find requirements for audio frequency equipment which is not of the type that is necessary for the repair of apparatus, but rather for the investigation purposes. Operations of this character are generally specified as being of unusual nature and requiring the services of "specialists." That may be so at the present, because of the limited application of the equipment, but even so, what prevents "an electronic maintenance man" (a better name than a service man) from becoming a spe-

(Continued on page 49)

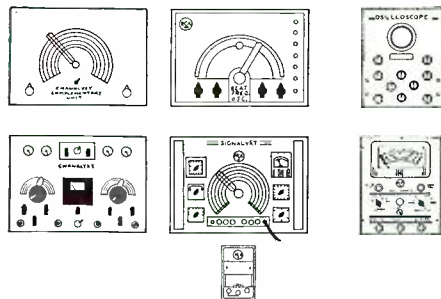

The completed service bench.

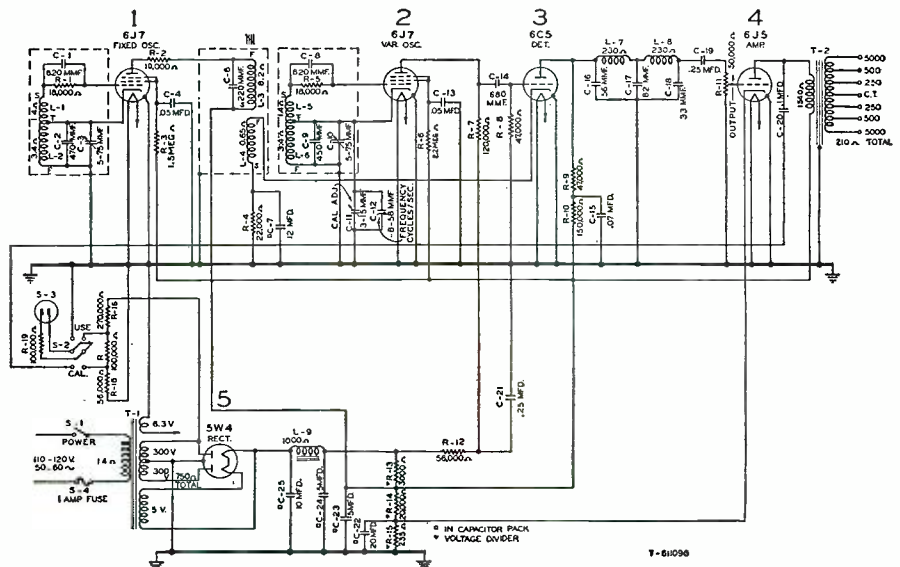

Circuit diagram of the audio oscillator. (After RCA)



What's **NEW** in Radio



Hallcrafters, Inc., has added to its line of marine radiophones the "Seagoing" Model HT-12, a 50-watt unit which combines wide operating range with the utmost in operating simplicity. Receiving and transmitting channels, ten of each, are crystal controlled to eliminate manual tuning and manual switching is avoided through inclusion of a voice-controlled automatic relay system.



A corrosion proofed metal case, 20 inches square by 12 inches deep, houses both the transmitter and receiver sections. On its front panel are arranged the few simple controls, the telephone handset, a built-in loudspeaker and a meter which provides a visual check on transmitter operation. The power supply is a separate unit and is available in two types, one for direct operation from a 12-volt ship's battery, the other from a 110-volt A.C. source. This latter type also serves where the supply is either 32 or 110 volts D.C., a rotary converter being utilized to adapt it to these supplies.

With the receiver channel selector switch set for the channel of the nearest shore telephone station (or for the ship-to-ship channel) the owner can keep in constant touch with what is going on and will hear calls intended for him. In addition, provision is made for connection of an automatic bell ringer which will ring only when his boat is called.

The receiver is a sensitive and selective 7-tube superheterodyne with one stage of pre-selection, built-in i.f. wavetrap and highly effective a.v.c. and q.v.c. systems.

Allied Control Company, Inc., 227 Fulton Street, New York City, have announced a new series of relays designed to meet requirements for a small, rugged unit of high-current capacity and low coil wattage operation. Applications are in mobile, marine, and aircraft fields, as well as for in-

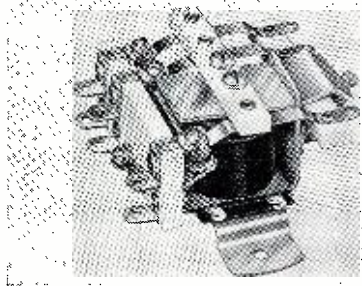

dustrial uses where compactness is a factor. Insulation is alsmag, bakelite or high-frequency bakelite. Contacts are 1/4" silver with wide spacing sufficient to handle 15 amps at 110 v a-c and 7 amps d-c at 110 v. Contacts available in 2-pole double-throw, 3-pole double-throw and 4-pole double-throw. Coil operation can be had from 6v to 250v a-c and from 2v to 115v d-c.

A new Power Tube Tester has just been developed by *Harvey Wells Communications Inc.*, of Southbridge, Mass., to facilitate taking accurate measurements of power and rectifier tube characteristics under variable load conditions.

The type R-83 tube tester was designed specifically for airlines and other organizations maintaining a relatively large group of transmitter installations, which must be kept at peak operating performance at all times. With the R-83 tester new tubes may be accepted or rejected after delivery and tubes in service can be checked at frequent intervals for correct performance.

The complete testing instrument is mounted in a single 83 inch steel rack cabinet which houses all the necessary meters, power supplies, and connecting circuits. The oscillator operates at 8 mc. and each power tube is tested for full rated output at this frequency, although a higher or lower frequency may be specified by the customer—according to requirements.

The following measurements may be accurately and quickly determined on a wide variety of power and rectifier tubes:

Filament current consumed at the rated filament voltage; Current consumed by the various electrodes at the rated voltage; Filament emission measured by reducing the filament voltage and noting the percentage reduction in power output; Total radio frequency power output at 8 mc.; Tube operation at voltages above and below normal rating; Rectifier filaments at rated filament voltage; and Rectifier performance at rated peak plate current, available current and r.m.s. voltage assuming a sinusoidal wave form.

Rectifier tubes may be tested in either a half wave or full wave circuit as indicated by the individual tube type. The load is of such a nature that the rectifier is subjected to its maximum peak inverse voltage rating, at the same time delivering its maximum peak plate current.

Individual power tubes are tested by means of a plug-in bakelite panel containing the proper socket and correct connections for the type of tube to be tested. Each panel is so wired that when it is inserted in the master panel, proper connections are automatically made to provide excitation and selection of the right meters and ranges suitable for the tube under test.

A total of six separate power supplies, each controlled by a variac, provide a wide range of testing voltages from zero to values in excess of tube ratings.

Further information and prices on the R-83 tube tester may be obtained from the manufacturer.

Like all *Hickok Tube Testers* this instrument tests tubes by measuring Dynamic Mutual Conductance in Micromhos (Patented Hickok Circuit). It is designed primarily to assist dealers in making more tube sales as it has a large 9" square meter with illuminated dial that clearly indicates Good—Bad—Doubtful for each tube so that there can be no doubt in the customer's mind. Readings are also given in Micromhos.

The Model 530-M tests all tubes including

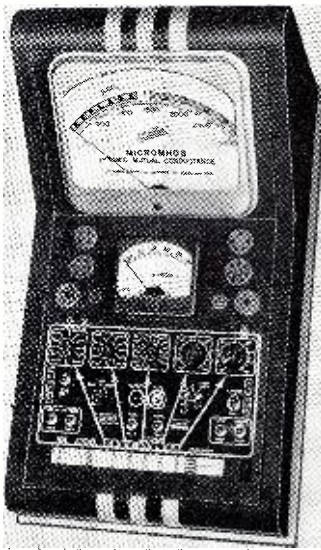

Ballast Tubes, Magic Eye Tubes, Miniature Tubes, etc. It tests for shorts—hot or cold. Contains a sensitive noise test and detects radio frequency noise. Has an accurate, sensitive gas test.

For complete data write the manufacturer, *The Hickok Electrical Instrument Co.*, 10301 Dupont Ave., Cleveland, Ohio.

New *Millen* item announced. Until now there has been no socket or shield available to electrostatically isolate the grid and plate terminals on the new single ended metal tubes so as to permit their use in high gain circuits. Such a shield has just been designed by *MILLEN* for use with their line of octal tube sockets. The illustration above shows the shield mounted on one of the sockets. It is made of aluminum. Manufactured by the *James Millen Manufacturing Company, Inc.*, Malden, Massachusetts.

Universal Microphone Co., Inglewood, Calif., has just put its new aircraft microphone on the market. Designed primarily for private aircraft,

it is also adaptable for mobile transmitters and marine installations. The single button carbon unit is in a bakelite case with moisture-proof cord. Model CU 1 is with three-way plug and model CU 2 with 109 A plug.

Special anti-noise construction damps out motor noises. Button impedance is 200 ohms and output is approximately 30 volts RMS across the microphone transformer secondary.

The double pole, single throw, press-to-talk switch connects the microphone and relay circuit simultaneously.

The usual jobber-dealer channels will distribute the new item.

Solar Manufacturing Corporation, of Bayonne, New Jersey, announces a new series of dry electrolytic capacitors in metal cans of the plug-in type to fit standard octal tube base sockets. These are known as type DO. This mounting is recommended where quick servicing may be

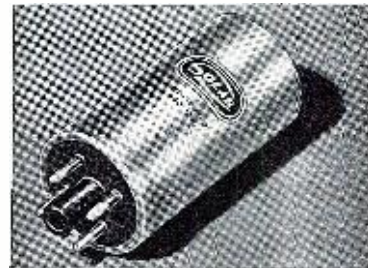

a factor, as in amplifier and transmitter installations. Straps are available assuring utmost rigidity of mounting under conditions of vibration, such as air or marine service. All usual ratings can be furnished, including multiple units.

Listing at \$39.50, Model 501, the *DeLuxe Portable Amplified Electric Phonograph* by *DYNAXOX* has plenty of sales appeal. A compact, handsome unit with smart-grained Fabricoid in black and popular colors. High grade motor



and crystal pickup. For AC operation, 110-120 volts, warranted to furnish a beautiful tone and plenty of volume. For information regarding other models in this complete line, write to *Dynavox*, 55 East 11th Street, New York City.

All three combinations are equipped with *Stromberg-Carlson's* new "Feather-Light Permanent Point" that reduces record wear by 10 to 1, allows playing of each record hundreds of times without noticeable damage to the record groove, and lasts for thousands of playings without having to remember to change a needle.

The new 520-PS was designed to fill the many demands received from the field for another Salem Chest model with doors opening from the front, and which included new *Stromberg-Carlson* phonograph refinements.

The 520-PS is an authentic Salem Chest Design in swirl mahogany that is completely front operated. When its doors are closed they simulate the drawers of a beautiful old Salem Chest. It is equipped to receive both standard and short wave programs and to shift and play ten or twelve inch records automatically. There are no needles to change and record life is multiplied ten times as a result of including the new "Feather-Light Permanent Point."

It employs a *Stromberg-Carlson* 12-inch Electro-Dynamic Speaker and is equipped with Tone, Automatic Volume, and Separate Bass and Treble

Controls. For tuning, there are 8 push buttons, 6 for favorite stations, 1 for dial tuning, and 1 for phonograph or FM or television connection.



There is a Stromberg-Carlson Slide Rule Dial and a Bifocal Tuning Indicator. Both a Short Wave Aerial and Knob-Controlled Shielded Loop are built-in.

Reoton Corp., 178 Prince St., New York City, declares that it has the only needle of its type (not being a jewel) which will cut 33 1/2 and 78 r.p.m. recordings with equal facility. This is the famous STELLITE Cutting Needle, with hard stellite inserted in a duraluminum shank.

Noiseless, hi-fidelity recordings assured for several hours, and may be re-sharpened. This needle has two patented edges, one cutting and the other polishing, leaving a smooth, shining groove. Said to be absolutely indispensable for "slow" recordings.

Radiart Vibrators and auto aeriels are now manufactured in this large, modern factory, owned by the Radiart Corporation. This move not only indicates the phenomenal progress of the Radiart Corporation during the past few years, but is assurance that Radiart jobbers, and their dealers, will be better served by virtue of



greatly expanded production facilities, and much more orderly production lines made possible by their new manufacturing home.

Electricians and Radio Men will welcome the good news that for the first time an automatic staple driver for all kinds of line-installations is now available.

This revolutionary product was invented by Walter L. Schott and is called the *Walsco* Staple Driver.

This amazing new patented tool sets the staple in place by a stroke or two of the palm of the hand at the end of the driver.

The head of the staple driver is so formed that it enables neat stapling around corners, moldings, behind pipes and radiators, etc., and through the new principle it is possible to install wires on hard walls, like mortar, plaster, etc., where an installation with ordinary staples and hammer would be impossible. It also speeds up stapling at least 50% and makes the job so neat that wires and staples can hardly be seen.

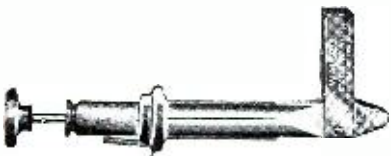

The *Walsco* Staple Driver holds strips of 24 staples and it takes about four seconds to re-load the driver. Staples come in 3 colors—ivory, brown and blue for wires or cables up to 1/4" in diameter. It is simple to operate, jam proof and is fully guaranteed by the manufacturers.

Full particulars about the *Walsco* Staple Driver and other *Walsco* products can be had by writing the *Walter L. Schott Co.*, 5264 W. Pico Blvd., Los Angeles, Calif.

A wide variety of new products has just been announced by *Consolidated Wire & Assoc. Corpns.*, 526 South Peoria St., Chicago, Illinois. Of interest to servicemen, experimenters, and amateurs alike, these new additions to the popularly priced *Consolidated* line include:

Two items of particular interest for use in replacement work on small radios—miniature dry-electric condensers in etched foil tubular,

etched foil waxed carton and midget plain foil waxed carton types; as well as a new series of midget double tuned I.F. Transformers.

A most complete line of radio cements and solvents.

A variety of phono and record accessories—including plain steel or brass plated high-fidelity needles.

A line of paints, varnishes and lacquers—including brush-on wrinkle finishes.

Two new broadcast and shortwave receivers, "Magic Rod" antennas offering a low price unit and an extremely high efficiency unit reasonably priced.

The *Daco Radiometer* "The Master Instrument" has just been announced by the *Dayton Acme Company*, manufacturers of the well known line of DACO radio testing instruments. The RADIOMETER is a beautiful streamlined instrument designed for the purpose of providing the service man with a complete laboratory in one compact instrument.

A vacuum tube volt ohm-milliammeter with 7" meter of 3,000,000 ohms per volt on 3 volt ranges and with voltage ranges to 10,000 volts is combined with an audio and supersonic oscillator of 20 to 150,000 cycles, and i.f.-r.f. oscillator of 50 kc. to 100 mc. range, signal tracer of 5 bands of video and amplitude modulators with 2 bands of frequency modulation, a 2" oscilloscope with sweep generator with range of 10 to 25,000 cycles and sweep amplifier of internal 60 cycle calibrated voltage and a p.m. speaker makes a completely synchronized unit of extreme dependability and flexibility for the service man.

This complete job is only 32" high x 24" wide with panel 19"x21" wide x 24 1/2" high.

Before the development of the RADIOMETER, the service man was compelled to buy individual or semi-individual instruments and the cost of the total of all instruments contained in the RADIOMETER would have exceeded \$500.00. The RADIOMETER list price is \$194.90 complete or \$179.90 without cabinet for rack panel mounting.

For further information write *Dayton Acme Company*, 2339 Gilbert Ave., Cincinnati, Ohio.

RCA Manufacturing Co., Inc., announce two new metal re-entrant loudspeaker trumpets and three new speaker mechanisms providing a variety of power.

Designed primarily for providing faithful high quality sound reproduction over large areas with exceptionally good directional characteristics, the new loudspeakers are entirely new additions to the line of standard RCA speakers.

Useful for large outdoor coverage, such as race tracks or amusement parks, the new horns are also ideally suited for use under conditions of high noise level such as may be encountered in industrial plants, indoor arenas, or skating rinks.

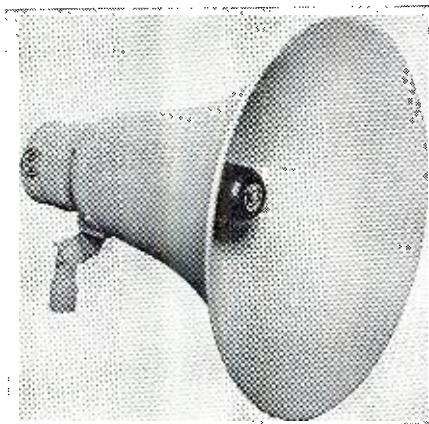

Larger of the two horns is the MI-6303, a 5 1/2 foot baffle folded back to a length of 31 inches. The bell diameter is 28 1/2", frequency response 150 to 7,000 cycles. The other is the MI-6302, a 3 1/2 foot baffle compressed into 19". Bell diameter is 21 1/2", frequency response 200 to 7,000 cycles.

The three loudspeaker assemblies, providing 15-, 12- and 10-watt power, are interchangeable with both horns.

The use of non-vibrating acoustic materials and a spun aluminum bell eliminate any possibility of horn rattle. This construction, together with the design of the re-entrant section to exclude weather from the diaphragm, make both speakers especially suitable for outdoor coverage.

LAFAYETTE Amplifier for low-power sound jobs. Although public address men like to think in terms of installations running into higher power and therefore carrying larger contract value, the possibilities afforded for the sale of low-power restaurant order systems, call systems, etc., are not to be overlooked. What they lack in unit sales value can often be made up in quantity sales, and in the ease of installation.

Typical of the better equipment of this type is the Model 406-T amplifier offered by the *Lafayette Radio Corporation*, 100 Sixth Avenue, New York City. Only 6 1/2" high, 9" wide and 7" deep, this amplifier is inclosed in a gray, wrinkle finished metal cabinet, fully louvred for

ventilation. Its output is 6 watts continuous, 8 watts on peaks. One microphone and one phono channel are provided with gain of 105 and 62 db, respectively. Frequency response is 50 to 8,000 c.p.s. but a tone control is provided to adapt the output to the acoustic requirements of each location. All parts employed in its construction are husky to insure long, dependable service.

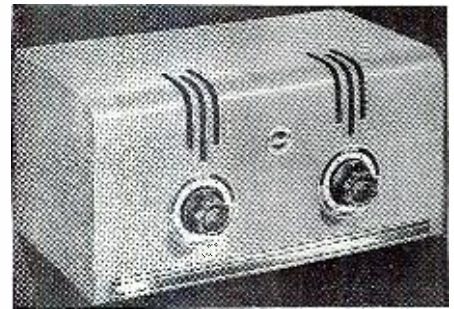

This amplifier is also available as a part of a completely coordinated indoor system, or of a portable system in a compact carrying case with built-in 8" PM speaker, crystal microphone and 9" banquet stand.

The THORDARSON 18 Watt Mobile Amplifier is proving to be very popular with the soundman desiring a sturdy, portable and inexpensive amplifier. The high efficiency of this universal amplifier when operated from 6 volts D.C. or 115 volts A.C. makes it well suited for all mobile and portable applications. It is conservatively rated at 18 watts, and the power output is sufficient for sound trucks, picnics, carnivals, and other similar installations. The amplifier includes an electric phono motor and pickup. Constant motor speed is assured from either battery or 115 volt A.C. operation, 10" or 12" records may be played.

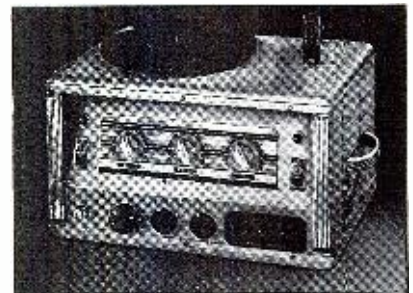

All input, output and power connections are made on the front panel of the amplifier which simplifies installation and eliminates cable interference when the unit is placed in the front seat of a car or sound truck. Amplifier controls are mounted at a convenient operating angle and are slightly recessed.

Separate microphone and photo volume controls permit mixing of record and voice, making possible a musical background during announcements. The tone control is useful for reducing record scratch and correcting for acoustical conditions. Finished in baked grey wrinkle with stainless steel trim, the Thordarson 18 Watt Mobile Amplifier presents a neat, compact appearance.

You are invited to write Thordarson, 500 W. Huron Street, Chicago, Illinois, or see your local distributor for complete technical information on this unit as contained in catalog sheet SD-462; or, if a catalog completely describing this and other Thordarson amplifiers is desired, ask for Amplifier Catalog No. 600-E.

Monsanto Chemical Company, Plastics Division, Springfield, Mass. A rich walnut cabinet molded of tough, strong Resinox. Monsanto phenolic plastic, distinguishes this Fada table set. There is no chance of time or hard usage harming the



body of the radio, for the color and finish are molded right in. Even the lettering and unusually designed vertical louvers are molded in one operation, making them integral with the cabinet.

(Continued on page 65)

Remote Radio Control

by Allen D. Rickert, W3EQX

Sonderton, Pennsylvania

Combining several ideas into one unit enabled the author to develop a remote control which puts his transmitter on and off from any room.

THE whole thing started in the most natural manner. W3EQX, my station, is located in an enclosed porch. With no heat supplied, temperatures of 50 degrees and lower, were not unusual. This, however, somewhat curbed the activity of operation during the colder months, though the urge was still felt. Coupled with this was the surprising fact that our particular broadcast receiver worked better on the short wave bands than my communications receiver. It naturally dawned on me, that my solution, for continued activity on the amateur bands, could only be solved by remote control. Immediately the thought of myriads of wires and cables flashed through my mind! There must be some solution to the excess wire problem, so I proceeded to delve into the current magazines for some solution for remote control with very few wires running between the two points.

The Awakening

After searching for quite some time I found several articles in various publications, ranging from RADIO NEWS, to Radio, that, when combined seemed to be just about the ultimate in remote control and besides there would be no wires between the two points, the only thing necessary to operate from any point in the house was an outlet plug for 110 a.c. and of course a receiver.

What I Found

In an article by J. Evans (W2BFD) Williams I found my means for control of the transmitter carrier. That was to place on, and remove it from, the air at will, by voice of the operator. An article in RADIO NEWS by N. C. Settle on a wireless mike, suggested the means of activating the voice controlled transmitter, from any point in the house without any attachment to the transmitter or its power supply, or by using any relays. By this time I was really interested.

Combined—I Have—

Looking at Figure 1, I see the circuit incorporated in my present transmitter, the oscillator portion of which it controls and the modulator from which its controlling power is derived. A very small amount of power is taken from the modulators. When any audio currents are passing through the modulator tubes, such as when the mike is spoken into, a very small amount of current is taken from the driver stage output and directed into the primaries of transformers T₁ and T₂, the secondaries of which are connected to the diode plates of the 75 or 55 control tube. The diodes rectify the audio frequencies and the rectified current creates a voltage drop across resistors R₄ and R₅ which are in series with each other. Resistors R₆ and R₈ are connected between the grid and cathode of the control tube. The d.c. voltage

across the grid and cathode cause the plate current to be reduced to zero, or cutoff. The plate current is drawn through the resistor, which is the normal grid leak of the oscillator in the transmitter.

With no modulation there is no bias on the 75/55 control tube and current will flow through the plate circuit of the tube, the plate current being drawn through the grid leak of the oscillator, will create a voltage drop across this grid resistor, which is sufficient to block the oscillator completely, consequently no signal on the air. But when the mike is spoken into the rectified voice current acts as bias on the control tube and the plate current drops to zero, hence no voltage drop across the oscillator grid leak resistor and the oscillator starts immediately putting the rig on the air.

The lag of oscillator control is dependent on condensers C₃ and C₅. This prevents the carrier from being removed between syllables and words. By experimenting with different values at C₃, the lag can be found best suited to your use. 4 mfd. was used here and gives about 5 seconds between words before the carrier is removed. In no case should C₃ be greater than .01 mfd. or trouble will be experienced in having the oscillator start quickly enough.

The plate supply of the control tube has its "positive" grounded and the cathode is placed at a negative potential of approximately 200 volts, though variations above or below this will not be critical. The plate voltage is obtained from the regular bias supply of the transmitter, since for this type of operation separate bias must be used on the transmitter tubes unless they are of the zero bias type. In the latter case a separate supply can be made for the control tube, as light duty parts may be used it can be made with very little cost. The filament can be connected to any source in the speech amplifier or separate transformer.

No Wires

Now let's turn to the remote control position. By referring to Fig. 2, we find the circuit of our wireless mike, which is nothing more than the modulated oscillator of one of the widely publicized wireless record players. This can be made to run from batteries which would make it truly wireless in that no connections would be required whatsoever; or as we did—that is, make it to run from the regular 110 volt mains. In the latter case, three tubes are used: a 6A8 oscillator, 6J7 modulator, and a 25Z6 rectifier. The circuit is simple and can be followed readily. This is, in reality, a small transmitter operating on about 550

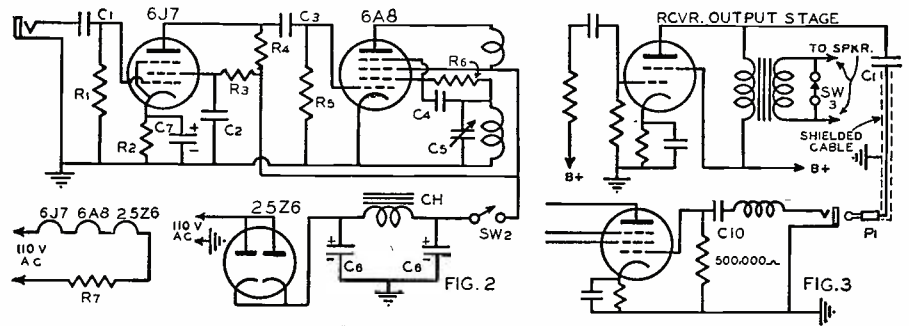

- R₁, R₄, R₅, R₈, R₉—500,000 ohms. 1 w. IRC
- R₂—3,000 ohms. 1 w. IRC
- R₃—1 megohm, 1 w. IRC
- R₆—10,000 ohms, 1 w. IRC
- R₇—225 ohms, 25 w. Ohmite
- C₁, C₂, C₃—.1 mfd. 600 v. Aerovox
- C₄—0.005 mfd. mica. Aerovox
- C₅—410 mmfd. variable. Meissner
- C₆—8-8 mfd. 450 v. electro. Aerovox
- C₇—10 mfd. 50 v. electro. Aerovox
- C₈—4 mfd. 450 v. electro. Aerovox
- C₉, C₁₀—0.01 600 v. Aerovox
- T₁, T₂—Audio Trans. Kenyon T 54
- SW₁, SW₂, SW₃—SPST toggle switches. Mallory

kc.; no antenna must be attached or the set is illegal.

How it Works

The ham receiver is tuned to the broadcast band—it might be well to state that the receiver may be any broadcast set that is not apt to be troubled with picking up the local short wave transmitter on the broadcast band—it is then complete into the input circuit of the speech amplifier of the transmitter, and tuned to an open channel near 550 kc. The mike oscillator is tuned to this same frequency, and now we're ready to go. Connections for coupling receiver to speech input are shown at Fig. 3.

Final Adjustment and Operation

For these adjustments it is best to have someone help by speaking into the mike while you make the adjustments at the transmitter. Start up the transmitter and receiver in the same manner as before. Now have your helper flip the plate switch on the mike oscillator, assuming that you have already found your blank channel near 550 kc., and have the mike oscillator and the receiver tuned to each other. Have the friend speak into the mike and you adjust the gain of the receiver to the point where just enough output is realized to excite the speech amplifier. This is quite important in order to keep down the receiver *qrm* to a point where it is practically inaudible. Otherwise *qrm* could operate the control tube and put the carrier on the air. After this adjustment, set the gain on the speech amplifier to a point where the desired percentage of modulation is obtained. If a peak limiter is used so much the better. Adjustment need not be quite as critical.

Now the air is yours for your living room easy chair, by the fireside: all you need do to put your carrier on the air is push your mike oscillator plate switch (voice operated break in is not recommended because the carrier from the mike oscillator has a tendency to operate the control tube and make operation erratic). Your stand-by is effected by opening the switch.

When operating in the shack in the conventional manner, simply remove the receiver plug from the speech input and insert your mike. To remove automatic carrier control switch throw switch *SW1*, disconnecting the control circuit from the oscillator and removing plate voltage from control tube.

-30-

COIL WINDING KINK

Here is a time saver for those who wind their own plug in coils and find it necessary to try several different numbers of turns before the right size is found. Wind more turns than you think will be needed and prepare the coil as you would if you were going to solder the coil ends to the form prongs. Let the wire extend through the end of the prongs about a half inch, so as to be grasped and drawn tight with a pair of pliers. Have a wood match trimmed to a point. Push the match into the form prong from the top of the coil until it holds the wire firmly in the prong. Cut off the part of the match and wire that extend from the prongs on the outside. This makes a quick and easily changed method of cut and try.

MIKES-HEADS-PICKUPS

Manufacturers Specifications

Make: Shure Bros., Chicago, Illinois, U. S. A.
Model: Stratoliner, 708S.
Type: Crystal (high-impedance).
Response: Rising, for best voice response.
Sensitivity: 33 millivolts for 10 bar speech signal at the 7 foot cable terminals at 400 cycles. (Equivalent to 29.7 db below 1 volt for 10 bar signal.)



Remarks

The model 708S Communications type microphone is designed especially for the intelligent transmission of the speech-frequency range at high efficiency. The unit is of the diaphragm type, pressure operated, having a Graphoil Bimorph crystal element. This is fully moisture-proofed. A built-in filter gives increased protection against r.f. burnouts when used with radio transmitters. This microphone is suitable for commercial and amateur radiophone, police and airway radio, high-efficiency voice-announcement PA systems, and similar applications where clear crisp speech signals are desirable.

The model 708S microphone is furnished with iridescent grey streamlined desk mount and a 7 ft. shielded cable and plug. Plug is concealed in the desk mount base. The connector has standard $\frac{3}{8}$ "-27 thread for stand mounting. A stand is not furnished with the unit. The cable is a single conductor, shielded, rubber jacketed type. The inner conductor should be connected to the grid of the first amplifier tube across a recommended load resistor of 500,000 ohms. The shield must be grounded.

The response of the microphone is such as to be most efficient at the voice frequencies and steadily rises in the important high-frequency intelligibility range. The use of a $\frac{1}{2}$ megohm loading resistor decreases the low-frequency response and tends to prevent excessive use of modulator or amplifier output power which is made available for the more important high-frequencies within the normal speech range. Lowering the terminal resistance below $\frac{1}{2}$ megohm will further decrease the bass response, while increasing the resistance will increase the bass response which reaches a maximum at 5 megohms. The use of a loading resistor of $\frac{1}{2}$ megohm is recommended for best average response at voice-frequencies.

Comments

The Model 708S microphone, although especially designed for communications, is also well suited to home recording where

most of the script is confined to the speech of persons, and sound effects. This unit will offer a distinct advantage over some of the more conventional microphones furnished as standard equipment with inexpensive recorders. Due to the limitation of frequency response, the heavy bass passages will be attenuated, or reduced in volume, so that overcutting of the record will be minimized.

This allows more freedom for the operator of the recorder, as he may take part in the performance without the necessity for "riding gain" at the volume control of the machine. A series of records were cut using the Model 708S with a conventional home recorder. In each case, a much higher cutting level could be employed than with the mike furnished. The noise level was reduced by several db and the quality of speech was most natural. Of particular note was the absence of high-frequency peaks and other overtones from speech syllables.

While discussing the applications of communications microphones it is well to stress the importance of providing a good ground connection between the mike, amplifier, and transmitter. Fatal shock can, and has, resulted from operators coming in contact with an un-grounded microphone case or cable. It is not enough to simply ground the mike to the amplifier—the amplifier must be grounded to the transmitter for complete protection. Then there is the matter of RF pickup in the operating room. Many amateurs use conventional mikes that were designed for the regular run of PA applications. These do not include a built-in RF filter system. These mikes, as a rule, offer the greatest danger to the operator from the standpoint of burns to the mouth.

Some speakers are never satisfied unless they "crowd the mike," and come in contact with the diaphragm grill many times during the period of a transmission. This habit should be overcome as it is not necessary for proper transmission.

The Reader Asks

Can a magnetic cutter be substituted for a crystal type?

ANSWER: Yes—providing the proper steps are taken to match the impedance of the magnetic head to the output tube, or tubes, of the amplifier. Most crystal cutters are fed directly from the tubes through a suitable resistor network to obtain the proper frequency response. If a magnetic unit is to be substituted—it will be necessary to add a matching transformer between the tubes and the cutter. Most magnetic units are available in low-impedance rating similar to voice coils of a loudspeaker. This type is very often well suited to the matching of the magnetic cutter. One should be certain that the transformer is of good grade, or the overall response will suffer. In some recorders, the output transformer for the speaker provided may be used by adding a change-over switch to transfer the audio from the speaker voice coil to the cutter.

Do the so-called "home recorders" include the features found in the portable recorders?"

ANSWER: As a general rule, no. The home-recorder is usually limited to the making of 10" records and will only include discs of this size, or smaller. They do not generally use the rim type of drive and are therefore subject to mechanical vibration from the motor assembly. The turn table, usually of 10" size, is rather light in weight and, therefore, will not follow-through when heavy bass passages are being cut. The recording head and the play-back pick-up are usually of the most inexpensive variety and this means that the response will be limited and that the distortion will be high in comparison to the better grades of portable recorders.

In contrast to the above, the portables are equipped with a heavier motor and the turn table, which is weighted, is driven by means of rubber tires directly within or on the outside surface of the rim. This method absorbs mechanical shock and provides a much smoother operation for the recorder. The

(Continued on page 54)

Ring the Bell

Why not go in for a bit of recording in your serveshop? It rings the bell!

by SAMUEL C. MILBOURNE

Serviceman, Greenwood, Miss.

HAVE you ever seriously considered the additional profits you might make from the operation of a recording studio in connection with your repair business? This is particularly worth considering, if you live in one of the smaller towns where home-life still forms the basis of all things worth while.

We do not necessarily mean that you should immediately lay plans to "heist" the local government lettuce depository for enough to make a down payment on one of those *super-super-duper* commercial jobs. Actually, you can concentrate on 10-inch or less records, at 78 r.p.m., and do a good enough job with a regular portable home recorder selling at less than \$100.

We can hear all our Recording Engineer readers emit a loud groan of protest. Remember, we didn't say a *good* job could be done, we said a *good enough* job could be done. The small combination home recorder-radio-phonograph of today is many times better than most of the semi-commercial units of yesteryear. If such a unit is operated correctly and kept in good working order, surprisingly satisfactory results can be attained.

This is not meant as any reflection upon the regular units designed for an honest-to-goodness recording studio, but, if the defects of the cheaper units are understood, and their limits are not exceeded, they can return a profit to servicemen and may serve as the starting point for better equipment at a later date.

The small table model type recorder-radio-phonograph also has the advantage of being portable and this allows the serviceman to pack up his recording "studio" and move it right into the parlor of Mrs. Smith's home where, incidentally, little Johnnie Smith is much more likely to do his stuff to the eternal honor and glory of the serviceman-recorderist.

Having the above suggested unit, what is the next move to make? Before you branch into the peddling of platters to pleased parents, there are several things which we found quite necessary to do.

First, go over the recorder from "bloup" to nuts. Make sure that you understand its operation thoroughly. See that all adjustments are made so that the very best recording possible can be made. Test several makes of records and use the make record which results in the quietest operation and the best sounding recording. Invest in a *good* sapphire needle. Do not use steel needles. They require changing too often, and, for recording in quantity, the sapphire needle is the cheapest

and best in the long run. Also, we suggest that you get one of the long-playing playback needles. This solves the question of playback needles for quite a while.

The next thing to do is to yank some obliging brats into your "studio" and experiment with, and on them. If they do not drive you completely insane, or the session does not wind up by their using the microphone for a football, you can consider yourself as "in." Remember, the fact that a child has



With all the opportunities offered in radio, if you can't make money—go back to repairing watches. Radio is for the wide-awake, energetic man.

little or no talent will make no difference to the parent. Just get the little fellow to lisp sweetly into the mike and you rate tops with pater and mater. Button your lip and suffer in silence, for if silence isn't golden it at least is silver lined in this case.

Inasmuch as 80% of your recording work will deal with children, you must steel yourself to the task of loving every shrill piping note and of laughing heartily at the cute antics of some little tyke who not only will not "give," but winds up by giving you the bird" for your trouble.

Seriously, you really must like children and be able to "handle" them if you expect to be successful in the recording business. Luckily, there are tricks to this trade, too!

Look at it from the child's point of

view. He or she has probably never seen you or your infernal machine before. Most children are instinctively wary of strangers and strange contraptions. You must sell yourself and your recorder to the child before the child will "give." Here's how. Keep a 10" record handy and use it for "trial" cuts. Explain to the Mother that you desire to make a trial cut to show the child "how it sounds." Give the microphone to the Mother and tell her to ask the child his name, address, age, what school he attends and the name of his teacher. These are things with which the child is familiar and which he will answer readily. Record the conversation and play it back. 99 times out of 100 you not only will have no trouble in making the final recording, but you will have an enthusiastic booster who will not want to quit.

Sometimes you will run across a child who is very shy and who does not want to perform before strangers. Tell the child that you will set the machine in operation and leave the room. Keep time with your watch and, when the selection is over, or the record is about finished, return and shut it off.

Another way to interest the child is to give him the shavings from the record, explaining very gravely that they consist of the child's words or song. If the child is under 10, show how very nice beards and mustaches can be made from the shavings. You will be surprised how quickly children will respond to this form of "making friends."

CAUTION! If you give the child the record shavings, be sure that they are of the *non-inflammable* type. This is important, because a stray spark from a cigarette will cause havoc with inflammable shavings and no child should be allowed to play with them.

Now, let us consider methods of advertising your recording service. First, before you do any regular advertising, we suggest the following publicity stunts.

Make arrangements with your local club or clubs to record all members' voices at their next meeting at no cost. Two 10" records, both sides, will give ample space. Everyone wants to hear his voice, although everyone professes not to. However, get a member of the Club at the mike who is well liked and who has a pleasing voice. Let him be the announcer and interviewer. Questions about business, family, and even prepared *easily answered* "Quiz" questions are well suited for this program. If you have a tongue-twister and a "cute" question or two, they will help

promote laughs at the playback, but be sure that you do not wound someone's feelings. Remember that you want to present a pleasing program, but primarily you want to make business friends. Watch out for "thin-skinned" people who might take exception to something the announcer fires at them, and who might blame you to the detriment of your business later on.

Next, start cataloging coming events in your town, and try to make arrangements to be there with your recording unit. You can record *parts* of the program on a 10" record and play it back later to the participants. For instance, let us assume that there will be a local Boy Scout Rally at which time the Mayor and several other citizens will talk, local entertainment will be furnished and several scouts will pass their tests or receive their badges. Place your microphone where it can pick up the program and record 30 seconds of each speaker's speech. Get it some place in the middle after the speaker has "warmed up." Do the same in the case of the entertainers and other participants. (*Ed. Note: Never stop the table while the cutter is on the disc. Use a separate portion for each series of cuts.*) Then turn on the turntable before fading in the next speaker. A slight pause will be noticed at each point where the turntable has been stopped and started, but this will not be objectionable if proper timing is used.

After the ceremonies are over, invite all participants to hear themselves. Explain that it was not possible to record the complete program, but that you have recorded a little bit from each offering. The main idea here is to whet the appetite of the speakers and entertainers for future complete records, and to advertise your services by word-of-mouth. Present the Troop or organization sponsoring the program with your record as a memento of the occasion.

Notice that in these cases, you are not only advertising your recording services, but you are obtaining a great deal of free advertising for your repair service. *This advertising method really pays.* We know from experience.

As a radio serviceman, you no doubt advertise in your local newspaper. Newspaper advertising is *not* expensive in small towns. A 2"—1-column wide ad on a monthly rate runs about \$10 in this locality (about 40 cents a day). Vary your service ads by including a message, once or twice a week, about your recording service. The following ads will fit a 2-inch, 1-column ad. Your name and address should be added at the bottom of each.

A general ad can be worded as follows:

"Hear your voice as others hear you. Do you know how your voice sounds to others? Make a record. You will enjoy it. It's fun. Phone 123 for appointment."

Don't miss the profitable possibilities of recording home talent on the local radio station. Haunt the children's hours, the quiz programs, etc. Make an arrangement with the local radio station for a "cut" on all off-the-air records they sell. An add for this market could read:

"Are you on the radio? If you broadcast from radio station WZXY, (Continued on page 59)"

SERVICEMEN'S LEGAL ADVICE



BY
TIMOTHY J. HEALY
Counselor-at-law, New York, N. Y.

IN this month's issue we continue with the discussion of leases.

In New York, the *Real Property Law* requires written authority to an agent to make a lease for his landlord for more than one year, in order that the lease may be valid. Where an agent therefore makes a lease in behalf of a landlord for a period of more than one year, it is important to be certain that the agent has written authority from his landlord.

Modification of Leases

In the case of *Nicoll vs. Burke*, 78 N. Y. 580, there was a verbal agreement that future rent be reduced from the sum agreed upon in a written lease. This modification of a future verbal contract is valid and lawful. Both parties acted under this arrangement and it was executed. The execution of the verbal arrangement made the modification of the lease valid. The law of New York seems to be that a written lease cannot be modified by a subsequent executory verbal agreement. The landlord can repudiate the verbal agreement at any time so far as it remains to be done and can insist upon performance according to the terms of the written lease; but so far as a verbal agreement is already finished, it becomes binding and the landlord cannot recover any amount deducted from the monthly payments which were made and accepted.

Occupancy Under Void Leases

The *Statute of Frauds* declares that a verbal contract for leasing land for a longer period than one year is void. While such a contract is void, yet if the tenant enters premises under it and occupies, he may be compelled to pay for the use and occupation of the premises. The theory of the landlord's recovery in this instance is not under the void agreement but under the *implied* agreement to pay a reasonable value for the use and occupation of the premises.

Verbal Evidence Rule

Under the *Parol Evidence Rule*, verbal testimony is not receivable into evidence to alter or vary the terms of a written contract. Where, however, the landlord and the tenant orally agree to modify the rent set forth in the written agreement and where that part of the verbal agreement of modification is executed and the landlord receives a lesser sum of money from the tenant in full payment for any particular month or months, that executed portion of the verbal modification is valid and binding upon the landlord. The landlord, however, is never bound by any such verbal agreement so long as it remains unexecuted and the landlord may therefore revoke or repudiate it at any time.

In *Halloran vs. M & C Contracting Co.*, 249 N. Y. 381, it was claimed that the tenant and the landlord entered into an alleged contract to grant the tenant the exclusive privilege to solicit customers in an apartment house and that this agreement was separate and distinct from the lease. The Court held that to permit the oral testimony of such agreement would have been varying the terms of the written instrument. The lease contained no reference to the privilege and yet the tenant's testimony was that the lease would not have been made if privilege had not been granted. The Court held that the covenant (agreement) of the lessor to furnish heat or elevator service or to make repairs is no more a part of the lease than would be his agreement to permit the lessee the exclusive privilege to solicit in the premises. That all would form part and parcel of one transaction and part of the consideration and that to prove such a contract by verbal testimony is not allowable.

In *Lewis vs. Seabury*, 74 N. Y. 409, it was held, however, that the promise of the landlord that certain specific fixtures then on the premises should be retained and remain there, so that the tenant might enjoy them, if she took the lease, was good as a previous distinct agreement made upon a separate and independent promise, did not merge in the subsequent written contract of hiring.

Premises and Interests Covered by Lease

The word "premises" when used with reference to conveyances signifies *lands* with other appurtenances.

In *Times Square Imp. Co. vs. Fleischmann's*, 173 A. D. 633, the Court said: "... vault space is not specifically mentioned in the lease... specific mention of the vault in the lease is not essential to its inclusion in the demise (premises). The fact of its being so included may be proved by circumstances, showing an intention to include it, such as conduct of the parties with reference to it indicating that they considered it a part of the demised premises. . . . That the parties themselves considered the vault a part of the basement, and covered by the lease, is shown by their conduct in carrying out some of the terms of the lease. . . ."

The landlord has the absolute right, by appropriate provisions in the lease, to specify that the leased premises can be used for a *particular purpose only*. Where the premises are to be used for a purpose *other than* those for which they are leased, a Court of Equity may, by injunction, prevent the tenant and sub-lessee from using the premises for any other purpose.

Covenants

In the absence of fraud or of a covenant (agreement), a lessor does not represent that the premises are tenantable and may be used for the purpose for which they are apparently intended.

In *Mulligan vs. Fioravera*, 228 A. D. 270, when the lease was made, there were no violations on the premises, and the Court held that it was a reasonable construction that it was contemplated that, if these premises were converted for use as a rooming house, at the wish of the tenant, necessary alterations should be made in accordance with the law. The New York Court of Appeals has decided that the Statute forbidding the implication of covenants (agreements) in conveyances of real estate does not apply to leases for years.

In a lease of upper rooms by the owner of the entire building, a covenant should be implied on the part of the lessor to give such support to the upper rooms as is necessary for their beneficial enjoyment. (*Graves vs. Berdan*, 26 N. Y. 498.)

Conditions

The words commonly used to create a condition are "upon condition" or "provided always" and such like words.

In *Ramer vs. Goldberg*, 244 N. Y. 438, it was understood that a license must be granted before the premises could be used as a dance hall. There the Court would not imply a condition which the parties chose not to insert in their contract, nor hold that the anticipated grant of a license constituted the foundation of the contract, when both parties knew that the grant of a license depended on the discretion of a public officer.

Use of Premises

Now what has all this to do with the serviceman? Just this. When entering into a lease for a store to be used as a service shop
(Continued on page 59)



Wayne w9foc Storch's swell qsl crd.

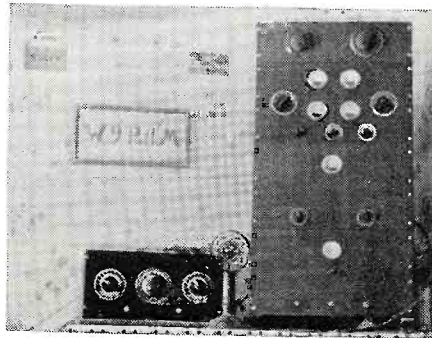

Clearwater, Nebraska's, w9ram.



Hamop w9nfd of Mpls., Minn.

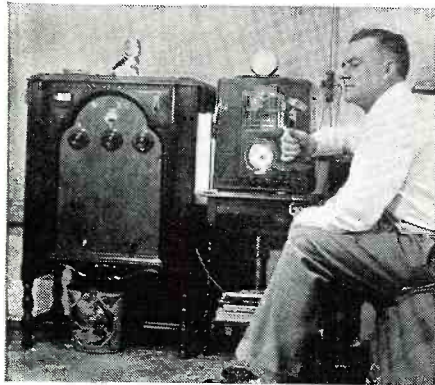

Hamop w9nxq es his rig.

H A M C H A T T E R

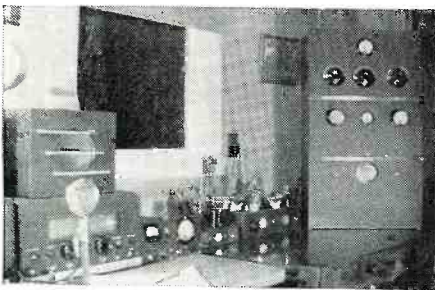

Quincy, Illinois', w9biq.

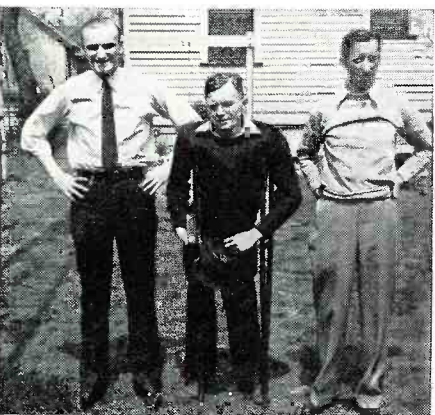

L to R. w9yfv, w9skr & w9hlf.

H. D. MILLEN, W1JOM, blasts in wid: W1DFS of Swampscott, Mass., is active on 75 fone. Walt usta be wid the RADIO SHACK CORP. OF BOSTON. At present he is doing electrical eng. on the SOUTH SHORE & don't get up to these parts vy often.

W1LDR of Boston, is nw down in Palacios, Tex. Don is a member of the 211th Coast Artillery Anti-Aircraft Unit nw stationed at Camp Hulen. Don is on 10 fone frm the camp & cums into Boston wid a real potent sig. He is running abt 12 wts into a HARVEY UHX10 and a V beam. His freq, by the way, is 29.136.

W1JUZ lives across the st frm KSF & they both wrk 10 fone at abt the same hrs! (Poor BCLs).

W1ADM of South Yarmouth on the Cape is on 75 fone. W1ILP of Milford came dwn on 75 frm 160 to see wat the bnd was like, but found it competish on his freq was a little too husky so he went up on one sissie.

W1DHS, is nw operating from Waterbury, Conn. George is running abt 700 wts on 75 fone. He is also active on 20 fone where he has a rotary beam fed by Bassett concentric cable 40 feet off the grnd. In order to rotate the beam George had to cut a hole in the roof of the house & cum u imagine, the landlord got sore. (Ain't sum of them awful unreasonable?) George has bn on 20 for more than 8 yrs & is planning on giving 10 a try shortly.

W1LZN is attending school at Lancaster. He is active on 75 fone frm the school station. The call is WILLV.

W1BCT of Leominster of 75 meter fame has bn playing arnd on 2 1/2 meters & 1 1/4. On the ultra hi he uses a trans tt wrks out fairly gd. W1MCW of Searsport, Me., skeds K6MNV on 10 fone.

Mel got his tiket on the day before the Rep. Thanksgiving & was on the air the same day. He is running 250 wts input to 75T's into a 1/2 wave doublet indoors. Mei by profession is an industrial research chemist. P.S. Ann, the xyl is by no means mike shy. hi hi.

W1IP is wid the Eng. Dept. of the HYGRADE SYLVANIA CO. in the vacuum tube divison.

W1GFW was testing his beam out wid an eco to see where it peaked on the band wid W1MGQ, & everytime GFW got anywhere close to MGQ's freq the rept wud be tt the sig wud practically go out of the picture. hi. Rudy is still kinda in the dark as to the reason his sig acts so funny in tt part of the bnd.

During a recent cold spell on the East Coast, when the temp went dwn to below zero, a W6 was ribbing a W1 & telling him hw warm it was on the West Coast. The W1 came back &

answered ft "no wonder, why wid all the heat radiated frm the Calif. KW's & the hot air in the mod, its enuf to heat the state of Calif. as well as a small part of Arizona." (Boy 'ats telling 'em.)

W1AHD bilding a nw rig wid the help of BDM. The rig will use T55's in the fnl & TZ-20's or 40's in the mod.

W1MIG of Boston is still up in Portland, Me. He is on 40 cw & 2 1/2 fone. Nick is trying to arrange a sked wid sum of the boys on 40 in & arnd the home town. He also has 2 1/2 meter equip but hasn't has any luck, due to lack of stations on.

When sum of u out of town boys cum down Boston way for a visit, or on biz & want to be prettied up, don't fail to drop in at W1KSA's. Joe (or better known to his clientage as "Butch") owns & manages a barber shop in Dorchester. The store is so up to date tt it contains a radio shack in the rear which the hams on use while waiting to be "worked" on. The need for this cn be seen by the large number of ham he serves. A few of his customers r: W1KXU, GF, JQH, AKD, MUD, CIB, MIG, AJA, JQA, LZA, EJU, BUG, MUB, IDU, GDS, LZV, KPX, LHZ, LYL, HYG, PI, AEZ, and SS. (No charge, this is purely ham gossip. hi, hi.)

W1AKD went port mobile up on top of Mt. Monadnock. He wrked 5 & 2 1/2 fone & on 5 repted tt he wrked into Conn. & up to the Vt. Canadian border, where he contacted a Forest Ranger running 1 1/2 watts frm a storage battery.

W1MUB wrking port frm Dorch. & Lowell on 2 1/2 meters.

W1MME one afternoon that he'd kill sum time between meals & decided to call "CQ K6." When he stood by on the band, to his surprise a K6 actually came back to his call. Will wonders ever cease?

W1KWD of Weymouth planning to visit Puerto Rico this winter.

K4GPS hails frm Newburyport before 1917 when he joined the Army. He serves as a veterinarian & holds the position of Major.

W1MMH of Quincy Point is a newcomer to 10 fone. George is running a pr of 60's in the fnl, mod wid 42's. The rcvr is a "Dana Bacon" homemade outfit.

W1KKI of W. Hartford, Conn., is over at M. I. T. in Cambridge.

K6PTW was wrking W1AJA & was looking arnd the bnd for W1MX. MX meanwhile was on the air talking to a local & complaining abt the lack of outside stuff on the bnd. Tsh, Tsh.

Who sez 10's dead. W1GOU frm Oct. 1, to Dec. 1st wrked 64 W6's, 22 W7's 13 K6's, the Snow Cruiser, a K66 in Canton Isle. Just a second, he just knocked off another K6. As w1 as loads of W5's & W9's.



Cedar Rapids, Iowa's, popular w9cvu.



L to R. W9-nbx, okm, abq, abt, lem & err.

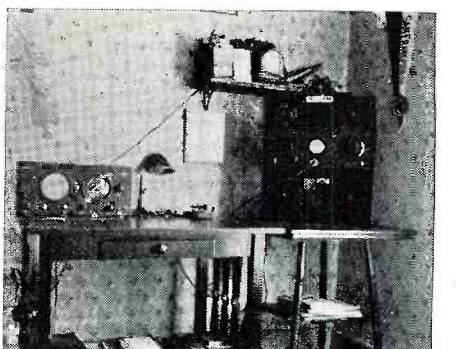

Hamstation w9vfm.

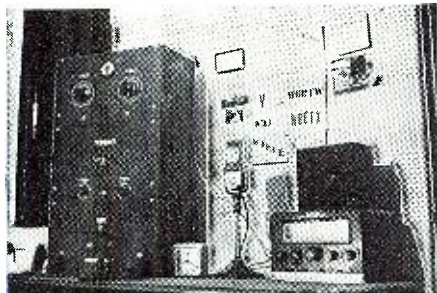

Hamstation of w9dnf.

Nw tt the custom of hving a separate room nr the house which was called (& looked like) a "radio shack" has almost disappeared, & the fad is to have a fairly decent looking room where the radio gear is kept (mostly due to pressure frm the family or xyl) the term on East it has become popular is the "CQ Room."

W11CI of Brookline running 80 wts to a zeppl and on 10 meters.

W1CIB & W1GOU r known arnd these parts as the "Salt Water Twins." They derive this handle not frm their aquatic art but rather frm the fact th both have recently moved to nw homes where their antennas r on marsh land tt is flooded on hi tides & surprisingly they both wrk out equally wl. By the way, at W1GOU's previous QTH he wrked out so gd tt a broadcast sta got wind of the swell way Eric was getting out, and they decided use the location as the site of the station. (If u don't believe it the sta is WMEX of Boston.)

W7HQG of Portland Oreg. has been coming thru fine biz lately in this neck of the woods. I don't know just what power he is using, anyway he certainly comes over ok.

W7IIB of Fort Warren Wyo. is one of the new Amateurs on the 160 meter band in these parts and has his rig working nice now.

W71JB of Wyola Montana is the other amateur who has a new ticket and is on the air now with about 50 watts to two 6L6s in parrell in final.

W7EKR works 10 meters and 160 with about 30 watts and works out fine bis on ten.

W7FDL, W7BHP (Bald Headed Preacher) and W7HSJ can be heard most every morning on the W7 breakfast club and occasional W7EYR and W7GPM are on the club too. W7FDL Mike the newspaper man of Rosalia Wash. is always and R 8-9 here. And once or twice a week W7FFW and myself (W7FHC) join into the rag chew with them.

W7IFC of Lewiston Idaho is on mornings occasionally trying to work some DX.

WGYYR of Potter Neb. and W9LPH of Farmington S. D. are two new mines I have contacted lately.

W71CC of Cody Wyo. is working 75 meter phone now mostly he was formally W6QUA of Losanges Calif.

W71BY, W7BWH, W7FTX, W7FVS, W7GLP and W7HDV are some of the W7S that have been barreling in here lately.

W7HWI (Hiwatha's Wooden Indian) Works at the Air port out Pocatello way when he is not exciting his TZ40's.

W7DAJ must have his house raised up now enough now so he can fasten on to his aerial as I heard him on the air a few minutes tother evening.

W7CDF (Cheveloets, Dodges and Fords) is still experimenting with different aerials seems he has a tower abt 60 ft. high a wants to make a triangle but can't get sticks from the lumberyard that is quite that high, looks like you will have to do one of four things Old Man of the Mountains no 1 forget the idea and try something else no 2 build two more towers, No 3 Splice out some sticks to get up parrell with his 60 ft. tower, No 4 Or Use your 60 ft. tower for a support for a vertical which are you going to do old Man. Which are you going to do?

Wouldn't it be swell if the next resident of the White House (in 1945) would be a ham? Awrite, awrite . . . we can dream can't we? Incidentally, the latest dope to leak through the censors, is that it was on the furrin ham bands that most of the dirty 5th Column work was done in Holland and Belgium as well as France. It is to the everlasting credit of the American Hamops that to date no 5th Column activity of any sort has been traced to them. We're damn proud that we're Americans! And furthermore, we don't care who knows it . . . and most of them do!



West Mass. AARS hamstation wkks.



Minot, N. Dakota's w9ztI.

FROM the Mail bag:

Dear Ed.:
Am a regular News Stand Reader and enjoy the Ham Chatter Department very much.

Read the letter from the listener on the South Caroline Emergency and Ham noncooperation in that one instance.

Its a pity that the BCL listener is unable to read code and get the real lowdown on the Hams and what they really do and not just get the impression that we are a bunch of nitwits like these fone guys in that particular case. These birds have their counterpart in the road hogs of the automobile drivers but we don't condemn the whole motoring public because of the selfish antics of the nut behind the steering gear, so the listening public should not judge the whole amateur fraternity because of the same class of hog behind a microphone. Sad to say there are even a few of these insects pounding brass.

We the hams should punish these offenders by the simple expedient of not answering their calls. And second to have their calls and their offense printed where John Q Public can see it. It would take a case hardened Ham to stand such as that long.

I believe that class C operators should not be allowed to use fone rigs in any band until they have had a years practical experience on air on CW and then an examination that would make sure they knew what it was all about before being allowed to put a fone rig on the air.

Most anything will work somehow on CW but everything has to be right in a fone rig or there is trouble.

I have nothing against fone stations or the ops because some of my best and closest friends are fone hams and I have the makings of a fone station laying around but keep so busy with traffic handling and BCL set repair work that I have little or no time to spare. Have gone so far as to wind some 160 meter coils however HI, and have a 3-inch Scope ready to do duty checking modulation.

Member of ARRL, and SCM, ORS, OBS, RCC, and Trunk Line J and also member of the Fort Traffic System or FTS, also AARS stn.
(Sgd) W4AXP

FOLLOWING appears on account of a few of the many stations, their locations by states and their operating frequency, heard at this location. These stations with very few exceptions were heard during the time of 12:00 Mid-night on, Central Standard Time, and is published as an experiment for two reasons. The first; that all readers may learn of the really fine reception and distance heard on the 160 Meter Band and second: that those needing certain states for W.A.S. may know where to look for them and/or know that even tho they may not have worked stations in the Chicago Area that they are being heard and thus give them an idea of their reach. We hope you like it.
(Sgd) W9BZT

Recent DX heard reveal the following Stations, States, Frequency, signal strength and data considered helpful.

Alabama: W4FGR, Bessemer, 1896. (v1) Q5A8, on every Monday at 1:00 A.M.; W4FVT/4, Selma, 1894, Q 3A6, not on regularly.

California: W6NUR, San Francisco, 1885; W6PZL, San Francisco, 1935, in very heavy QRM.

Connecticut: W1LQZ, Danbury, ECO, every morning; W1HPR, Elmwood, 1884, fairly regular.

Florida: W4CPG, Maitland, ECO, week ends mostly; W4FZR, Tampa, 1878, in vy heavy QRM.

Georgia: Have heard one station about 1810 but did not log his call.

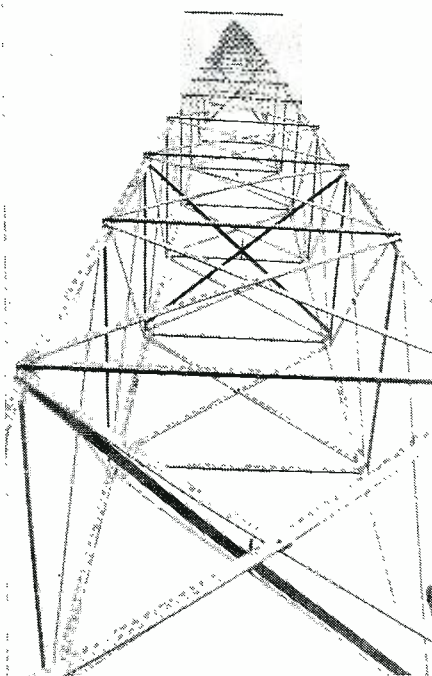

A 60' tall tower belonging to w9biq.



Fake operator, indeed! Bill's OK, hi!



CCC 797 hamstation w9okm-wufd.



w9erw & w9irz's sister Allyne.

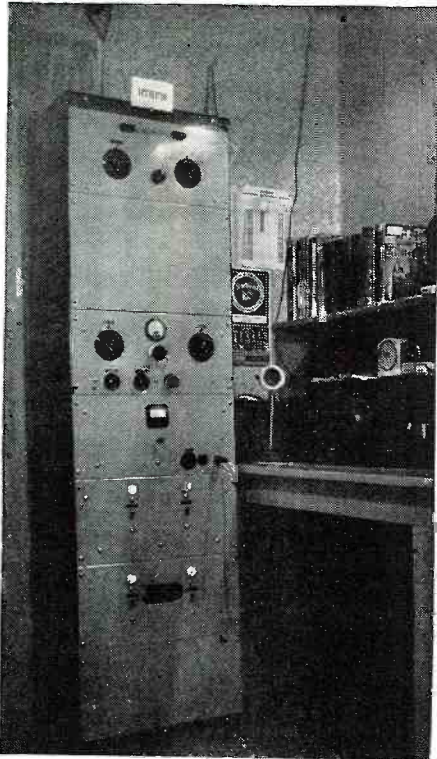

Hamstation of w7hph.

Kansas: W9HEC, Independence, 1912, not regular.
 Louisiana: W5ZS, Shreveport, 1894.
 Maryland: W3HR1, Baltimore, 1888.
 Delaware: W3DNH, Newark, 1887, very strong.
 Michigan: WSUVW, White Cloud, 1835, also 1912, regularly.
 Minnesota: W9EJN, Virginia, ECO, regular; W9NFD, Minneapolis, 1894, each Monday morning 1:00 A.M.; W9MSL, Duluth, 1952, mostly early evenings.
 Mississippi: W5HLY, Tunica, 1892, each Monday A.M.; W5GJP, Biloxi, 1899, daily.
 Missouri: W9IDL, Kansas City, 1894, daily; W9NIP, Columbia, 1882, Monday A.M.
 Montana: W7FXO, Scobey, 1886, 1974 too, at intervals.
 No. Dakota: W9BBD, Fargo, ECO, week ends; W9HBR, Rawson, 1894, 1970 also, at intervals; W9BOP, Minot, 1916, not regular yet.
 Nebraska: W9RUJ, Auburn, 1894, each Monday A.M.; W9BJJ, Lincoln, 1839, also 1891, daily; W9QMY, Lincoln, 1885, not regular yet.
 New Hampshire: W1MAS, Hillsboro, 1894, usually Monday morn's; W1OE, Penacook, 1886, infrequently.
 New Mexico: W5ISW, Hobbs, 1885.
 New Jersey: W2KYH, Ridewood, 1902, daily; also W2NIW.
 New York: W2FDI, Albany, ECO, also W2NGH on 1875.
 Oklahoma: W51WW, Tulsa, 1975, mostly evenings; W5HFY, Tulsa, 1892, daily, on 1810 also.

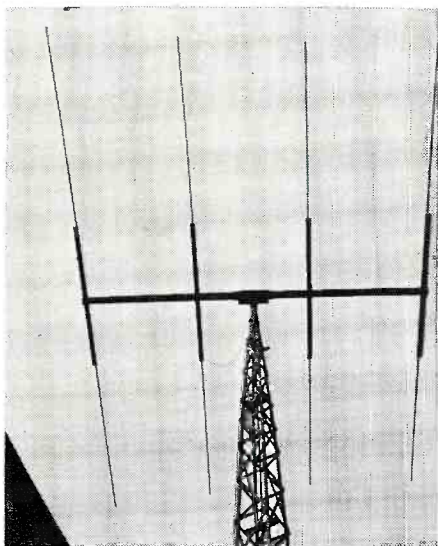

A super-swellgent beam of w9skr.



w9okm.



w8naf.

Ohio: W8RHZ, Cleveland Hts., 1916, daily.
 Pennsylvania: W8BKH, N. Kensington, 1885, infrequently.
 S. Carolina: W4GEX, Greenville, 1908, (xyl) mostly early eve's; W4CPS, Greenville, 1894, Monday A.M.
 S. Dakota: W9HRR, Mission, 1882, early evenings mostly.
 Texas: W5GEP, Corpus Christi, 1885 infrequently; W5LLK, Electra, ECO, each Wednesday morning; W5JCM, Dallas, 1886, very often; W5BUZ, Port Arthur, 1901, semi-weekly.
 Tennessee: W4GCB, Memphis, 1890, at least weekly; W4GSP, Newcomb, ECO, at least weekly.
 Utah: W6TCC, Provo, 1975, heard just twice.
 W. Virginia: W8VBX, Putney, 1883, very often (4 es 60 W); W3IIF, Portsmouth, ECO, very often; WSATT, Nellis, 1887, daily.
 Wyoming: W7HEY, Midwest, 1962, Monday mornings.

GENE (W9EZC) writes:
 W9FDA is happy—he won an HY30 at a Hamfest. He's using it in the rig.
 W9BVB is building a big rig for 10 m. Also has 25 odd watts on 2 1/2.
 W9WZO & W9EZC are recording transmissions etc. W9WZO has 30 W. on 2 1/2.
 W9MSB has a 3 watt portable 160 fone. Has worked Wisconsin & Michigan. You can spot him by his low-pitch hum on fone. Hi, Wes!
 W9VH is now located in Naperville & is sometimes active.
 W9BVB left the printing of the *Naperville Sun* to somebody else and is now with *Cox Electric* in Downers Grove. Is working on his future job (he hopes) at WMRO.
 Your reporter saw W9PQH and W9DXE's daughter Madeleine at 1:00 A. M. on Aurora. We had a fb ragchew.
 W9LNP is new ham in Eola—W9MWL's xyl she is.
 Hamfest saw W9BVB, EOT, ELF & Yls, MSB, & XYL, WZO, EZC & friend Al.
 New ham to be here is Jack Givler W9???. He has Howard 435 rcvr & a transmitter ready for the ticket.
 W9EOT is building a transmitter. 6L6 6L6 6L6 combination.

S. B. ROBBINS, W5IQF, reports:
 QRR on 160 cw wid 6L6G osc es RCA 812 in finl wid 800 jolts B Batts in recent ice storm sum fun workin by candle light wid bio-torch es iron puttin battry to sky buddy es rig on changin from trans to recv pos. 1st contact 7 control sta Nebr. 2nd Denton, Tex.

W5ALE has joined the monitoring staff of the *F. C. C.*

W5EZV is renewing old acquaintances in the USA while recuperating from injuries received in an airliner crack-up in Ecuador. South America where he is a radio op for *Panagra*.

W5CVO has joined the engineering staff of *KLRA*. All engineers on the staff have their amateur licenses also.

W5ELM has moved to Pocatello, Idaho, account of work.

W5DQB has joined the monitoring staff of the *F. C. C.* and is now stationed at Little Rock, where he hopes to have a station on the air soon.

AMATEUR Radio Station W4GFF, Cordele, Ga., says:

W4EEZ in Athens, Ga., is back in the Army net and we're glad to have 'em W4FDE is back on in Cordele, Ga. And is active once more.

Walter Purecy W4HFK is a new ham in Cordele. After waiting five months. Doc. W4FCW has changed his QTH Camp Jackson, S. C. He is Cap't now. Hi.

W4FFI Bob Williams. Has moved and is off the air at present time. W4AZK Dave Straer is working at a commercial station in Alabama now.

The boys in Valdosta, Ga., W4GKX and W4GBT



w8ouz.



w9yum.



From Great Bend, Kansas, comes w9dqz.

are heard almost every night. And it seems as if they're increasing power. More QRM Hi.

W4EQB in Montezuma, Ga., is going around buying transmitters. They say he pays cash too, so boys, there is your chance.

W4GBO the Atlanta, Ga., policeman is back on the air with a good signal. W4HFB is a new HAM in Tifton, Ga., with a 100 watts. fb Bob. W4GRP is heard on the air early every morning. Too much QRM at night he says. So keep up the good work George.

Orland Duncan W4FAH has moved to Eastman, Ga. He works both phone and CW. W4FDJ POP Morgan at Lyons, Ga., is calling the army amateur net now.

W4GLB and W4GSV at Albany, Ga., work for Sears Roebuck Co. now.

W4ECO in Panama City, Fla. Sure has a fine business signal on 160.

The W5's sure do roll in this part of the country now.

W4HAE is in Athens, Ga. Attending the University of Ga.

W8EDD is working fixed portable 4 at Miami Beach, Fla., with a fb signal.

W4CVK is working 160 phone in Clearwater, S. near Augusta, Ga.

W4GHW "Goat Head Willie" is working the high end of the band on 160.

W4FRF has given up ham radio for aviation. The Flying Farmer Hi.

W4FRQ "Pent" is on 160 in Panama City, Fla. Has about 200 Watts.

W4FOO at Fender, Ga., has 3 rigs now. Seems to be in the business.

W4DSB Ed Moek is on 75 phone in Americus, Ga.

W4FNY has hi power in Brunswick, Ga.

W4GCD is head man now at WGOV in Valdosta, Ga.

W4GFF is trying to get something on 10 meters in Cordele, Ga.

The Crisp County Radio Club has got to elect new officers before their Annual Hamfest in July.

QRM from the 5th Dist. by W5HMY Windy Bill.

Well here we go again starting off this month with a few choice stories.

Have you heard the one about the ham in New Orleans, La., whose call ended with a "y" and insisted that "y" stood for Wyoming? hi! Then there was another down there who received notice to come to the customs house and upon arriving was questioned about calling an XE in Mexico whereupon said ham said he didnt see where he was breaking any law so the R.I. says dont you know where Mexico is the ham came back and says he sure its right over there next to Fla.

W5EKV is back on the air remote controlling his rig and doing a nice job.

W5GQW Lionel thinks politics should never



Hamop & station of w9pdh.

be discussed on the air.

W5IHL in Jennings, La., is on 160 fone with a sweet sig.

W5LTP is an old timer from way back on fone in Donaldsonville, La.

W5AZA says if W5DAN doesn't like his handle of Jimbo to forget about because he didn't name him or raise him.

W5HGL in Houston, Miss., is on 75 fone helping W5HZP on 160 put Houston on the map.

W5CQJ has a new speech amp. that really is the stuff.

W5DAN is back on 75 and threatening to come down to 160 (please don't, Curly, it's bad enough now).

W5EWD is back on the air on 75. Jewel really has a nice sig.

W5BID in Amite, La., has been on 75 for many long years.

W5JGO is a new comer on 160 fone with a low powered rig in Baton Rouge, La.

W5EES is operating fixed portable on 160 in Houston, Tex.

W5I2S, W5I2C es W5HQC are all in Jackson, Miss., on 160 fone 5I2S is op in theater W5I2C is an X 40 cw man.

W5IRO runs two KWs on 160 es 10 Charles says he got so much ham equipment for Xmas he doesn't know what to do with all of it. (my QTH is ok in call book, hi!)

W5ITY in Lafayette, La., is back on 75 for the winter. Mack has been on 20 all summer.

W5ECT old Louis in Laurel, Miss. puts out a nice sig.

W5JDU is another new one in New Orleans on 160. Clyde gets out FB.

W5NI in Bastrop, La., is also an old timer who likes to work the lids on 160.

W5IJJ whos handle is Beans, on 40 cw in New Orleans has a very interesting story as to how he got his handle hi.

W5IUG is revamping his rig on 160. Old Doc already puts out a hefty sig but has a lousy line noise.

W5GXO will go to high power on his rig if W5DAN will do the same.

W5IKP is now running a KW on 160; in New Orleans Maurice is known as the biggest liar in 160 fone hi!

W5HHT is owner of *Radio Parts Inc.* in the Crescent City but you would never know it by working him on the air (what's this plug worth?).

W5AVO is undoubtedly the most easily pleased ham in the world when it comes to ham equipment. Old Bob is busy building him self an eco that will track with his revr, he hopes.

W5BLQ has at last got the ac hum off his carrier. Hi, Jack.

W5ECH, old Pick, in Alel, La., says his favorite radio program is Two Gun Thompson as put on by W5HMV.

W5HMZ will soon be getting up at all hours of the night.

W5ITS es W5JJE are active in Winnfield, La. W5IKV was a witness to a terrible accident. Ask him what he did with the remains.

W5HRX in Biloxi, Miss. now has one of the best sigs on the air.

W5HCE is on 160 modulating a FB AC hum; hi!

W5IEF is now xmitting from Independence, we hear.

W5RPT es W5OZA wound up the CRA code classes which they were teaching.

W5VCC donated nice oscillator to Cleveland Radio Assn. for future classes.

W5TNP's XYL studying for her license.

W5UBC is ex-W5CCC's xyl.

W5BDS wants to sell one of his fone rigs. Says he expects to settle in Toledo soon.

W5UKR gang recently held a party in club H.Q.

W5UNA es W5UYN have new "bugs." Cleveland gang sporting a lot of new meters also.

W5PWY's hobby of photography keeping him busy.

W5GW also a camera enthusiast.

W5SSV decided to get back into the game also but his xyl helped by breaking the largest photoflood and ruining one of his reflectors—hi.

W5TLQ has been grinding a mirror for a new telescope so he'll be sure to see that comet's tail.

W5MMZ now has title of Chief Radioman and is "vacationing."

DOW W9KOH Summers pounds out:

W9AHP is sporting a new NC200x receiver and seems real pleased with it.

W9IFR finally got those T55's perking and has a fb sig. with 400 watts now in the high end of 160 meters.

W5JIP is doing a fine job now with only 40 watts into a Stancor 60P rig. Nice going there Scott.

W4FZA of Memphis put a wicked sig. up to these parts too.

W9WSE has his chest out about 18 inches above normal now, reason one new boy Op. Nice going there Hersh.

W9ELY up in Oshkosh is doing a fine job b'gosh with 40 watts and says he prefers low power, sound like that's all he needs, fb Bill.

W5JIV is a new ham in Buffalo, Okla. Welcome on 160 meters Walter.

W5HSX has a fb sig. from Houston, Texas, with 50 watts, call me again Bud and Lou.

W9JOG is a new fb sig over in Maryville, Mo. Lots of dx in '43 to you Chuck.

W9HZZ has a duplicate of my station, a new Hallcrafters HT4 transmitter, and a new SX 28 receiver. Congrats Bill I know you are one happy ham.

W9GZR of Joplin is doing fine with a new antenna.

W9WEM formerly of Kirksville, Mo., is now operating his station at Trenton, Mo.

(Please QSY to page 63)

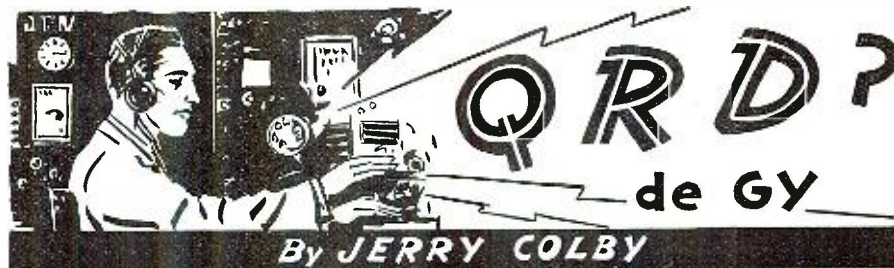

BILL HR 10446, recently introduced into Congress by Representative E. V. Izac, authorizes the FCC to suspend the license of any radiop who may be suspected of membership in the *German-American Bund*, the *Communist Party* or any organization "subject to foreign control" upon proof sufficient to satisfy the *Commission*. On the face of it, doesn't this bill mean that American vessels should be manned only by American radiops who are thoroughly in accord with American principles of government? We feel sure it does. Yct we find that the *ACA* in its publication *MSG* (Nov.) sez, "it becomes the job of every *ACA* member to rally to the *Union* in its drive to defeat the *Izac Bill*". Their contention is that "any radiop who is a staunch trade unionist can be railroaded out of his livelihood at the desire of a shipowner. . . ." We wonder whether this lame excuse is but a cloak to hide the real reason for their desire to defeat a bill which, in our humble opinion, has the interests of America and Americans at heart in its attempt to keep sabotage of our transportation and communication systems down to a minimum. We thoroughly believe in the *Bill of Rights* and in the liberty-loving principles of free speech and freedom of the press. But we have come to the conclusion that in the past few years these ideals have been stretched to the breaking point by subversive groups intent on doing harm to our nation, to the one country wherein liberty and the pursuit of happiness are freely permitted. In our opinion this Bill should be upheld as an American proposition and we urge our readers to please wire, write or phone to their congressmen to make all haste to pass this bill.

WE have found that when an attack is made on labor, both the *AFL* and the *CIO* organizations stick together in combating their attackers. But in the case of Bill HR 10446, the *AFL* affiliated *CTU-Mardiv* is definitely not standing with its rival radiop union, *ACA*. They are firmly for the passage of this Bill and are prepared to lobby on the floor of Congress to make sure it meets congressional approval. Now, why should one radiop union be for it and the other agin' it? Isn't *CTU-Mardiv* trying to better its members' working conditions? Hasn't *CTU-Mardiv* endeavored thru the past three years to win the security of billets for its dues-payers? Doesn't *CTU-Mardiv* want the best for its "boys"? Haven't the past three years proven to all radiops that the *CTU-Mardiv* officials are intelligent, farsighted unionists who have fought to build up a strong union following against the greatest of odds? Well, *CTU-Mardiv* is for Bill HR 10446 and *ACA* is agin' it. Just don't make sense. . . .

ALSO in the *ACA* publication, *MSG*, appears a letter signed by one Arpard A. Fazakas, *ACA* member, who sez. Quote: "The *Selective Service Act* violates the XIII Amendment to the Constitution in that it provides for 'labor battalions' at \$30 a month which in my opinion is—and in truth is—Slavery! This act violates freedom of speech and press in that it forbids any person to 'counsel' another to evade registration or service." Unquote. Although Mr. Fazakas states this as "his opinion", we would like to point out that the bill being a violation of freedom of speech is untenable in law and in fact. We have had for many years a statute on our books which holds the man who *advises you against* the payment of income tax liable, and no such cry was ever raised against it. It is our opinion, (if we may) that any person who counsels another to evade registration and service is committing an act of

sabotage and should be treated as a saboteur. If the *ACA*, in particular, and trade unions in general, are consistently going to be obstacles in the path of national defense, the time may come when, by virtue of dictatorship, there will not be any unions at all, or any rights for anybody. Although this thought may not mean very much to those who have nothing to lose, you who wish to uphold our American form of democracy should do everything possible to educate those who are making our "Civil Rights" the laughing stock of dictator nations' propaganda agents.

WE may be naive, short-sighted or what-have-you but we think it's about time that we submerge ourselves as true Americans, lucky citizens of this great USA, and extend all our help to those who are working day and night trying to forge the weapons necessary to make this nation the mightiest country in the world. Let us take inventory and give a thought to giving instead of taking. We have been like the Chinese who, after being the most warlike and courageous people on earth, built a great wall around their domain and turned their minds into the channels of freedom and poetry. They turned soft and soon thereafter smaller but better prepared peoples came, climbed over their walls and made vassals of them. We have turned soft because our freedom gave more to us than to any other peoples on the face of this globe. But we still have time to toughen up if we will aid instead of deter those whose background and experience fit them for the difficult task of getting us into shape.

WE had heard and read much from various sources about a chap named Anderson, an official of the *CTU-Mardiv*. We even received a short epistle, the tone of which scared us a bit. We had visioned him as a powerful brute. Imagine our surprise when he recently paid us a visit and, soaking wet, he wouldn't have weighed more than half a dozen cream puffs. (However, remembering that Dillinger, the gunman, was a little guy, too, we sneaked our trusty 45 from the desk and had it handy, just in case.) Well, after a couple of hours bating our gums over the current marine situation, we gathered that this gentleman was well informed on the national situation. The fellow backed his statements up with proof from which we culled. Quote. I feel that the menace of Communism and Bundism espec-

(Please QSY to page 61)



Captain: "Well, fix it!"



by **ROBERT KENDALL**

Service Manager, Indianapolis, Indiana

Penny Wise

▶ **HOSE** who have an abundance of time and coin of the realm, plus an inordinate love of talking about themselves to strangers, may find great satisfaction in consulting the psychoanalyst, who for a few hundred dollars will listen indefinitely to one's innermost thoughts and soul-searchings, and in return will pass out a number of flossy technicalities such as "extrovert" or "introvert" as the case may be. Since it is not likely that many radio men can indulge in such luxuries, we follow RADIO NEWS customary policy of giving extra value, and offer our readers their choice of these ten-dollar words, all for the small cost of this issue.

By reference to that invaluable work of Mr. Webster, who knows all the answers, we find the "extrovert" has his interest directed outwards, gaining satisfaction from externals, which we assume includes such things as beer, malteds, movies, pretty girls and the society of others in general. On the other hand, the "introvert's" interest is directed inward, and is preoccupied largely with his own thoughts, which often leads to the droops, and a condition of general dopiness. On the whole the extrovert seems to have much the best time of it, and one way to arrive at this happy state is to take a healthy interest in the ideas and opinions of others.

That is one of the reasons we like to pay our friends and acquaintances in the trade an occasional visit, when we are in their vicinity, and the resulting exchange of ideas usually is well worth the small amount of time expended. If nothing else, we often come away with the feeling that we do things better at our place, which is comforting to anyone.



Voice from tank: "See if you can receive me in there. Headquarters can't."

Last week we dropped in on a friend, and found him exploring the works of a large chassis, which was rather teeteringly propped up by a couple of tube cartons; and as we exchanged a few bits of gossip he picked up a spare condenser and began to apply the leads to various terminals in the set. Suddenly he bounded away a foot or so from the bench, and loudly ejaculated a number of Biblical terms with much feeling, as the chassis went over with a crash, landing on a volt-ohmmeter beside it.

As comparative calm was restored we approached the bench for a survey of the damage, and found one power tube shattered and the dial frame badly bent, while the glass of the volt-ohmmeter was smashed and the pointer bent up at a right angle. Judging that a man who has had 250 volts unexpectedly shoved up his sleeve, and about five dollars added to his overhead is in no mood for unsolicited advice we avoided that infuriating statement "Now what you should have done," and hastily scrambled for the door, saying, "That's tough luck" in a soothing tone of voice.

We used to have such scenes around our shop now and then, until we decided it was a rather expensive economy, and took a little time and a couple of dollars to build up a simple condenser substitution box. We make no claim to originality for the idea, as such boxes have been often described in the past; but a surprisingly large number of men are without this useful gadget, and generally those described in print are unnecessarily elaborate and expensive, as the constructor usually goes to extremes and includes nearly every known capacity. From daily experience we find that four or five sizes will adequately cover the customary requirements of such testing, and the box now used contains only four condensers (10 mf., 0.5 mf., 0.1 mf. and .001 mf.), a tap switch and two binding posts for the attachment of ordinary test leads.

The 10 mf. condenser is an electrolytic with a 450 volt rating, and is large enough to serve as an audio by-pass or ordinary filter condenser. The .5 mf. paper condenser is most useful for shunting across grid or plate circuits when running down hum, while the .1 mf. condenser serves for substitution in AVC circuits, as an audio coupling condenser or screen grid by-pass. The .001 mica condenser is a good compromise for substitution in circuits where small capacities are used. The low cost of such a box will be more than repaid in convenience the first week it is used. Be sure to indicate

the polarity of the electrolytic at the binding posts.

Third Hands

HOW often have you spent five or ten minutes searching for tube cartons, boxes or blocks of wood the right size to prop up an unsupported corner of a wobbly chassis, only to have the whole affair collapse as soon as you make a pass at it? This is just one of those things we are slow in doing anything about, probably because it is only lately that manufactured chassis supports have been available. There are several good devices for this purpose now on the market, and one of the most practical and inexpensive we have seen is known as "radio jacks," consisting of a cast iron base with a sliding rod that may be adjusted for height and locked in place. A pair or two should be ample for most small shops, and may be obtained without any undue strain on the budget, as they may be purchased for considerably less than \$1.00 per pair.

Service on Credit?

IN a recent letter on service conditions in Mississippi, our versatile and voluble correspondent Harold Davis reports:

"In the case of good, honest hard-working people who just have not fifteen or twenty dollars to turn loose at one time, some of my prodigies extend sixty, ninety or even one hundred and twenty days' credit, getting a third or fourth on delivery of the set, and the balance in three or four monthly payments. If the proper type of person is selected we find that very little trouble develops in collections."

"Now we know that many servicemen will argue with you on this system, but we can point out some men



"I always wondered why they made those antennas so long. Now I know."

who are using it, and who are eating regularly, in fact they even have an extra dollar or two lying around. The trouble with most servicemen is that they get in a rut and start replacing coupling condensers at \$2.50 and never try to work up a good sized job that will pay them a nice profit."

No doubt these words will sound strange to the man who for several years has conducted a service business on a strictly C. O. D. basis, but there is good common sense in re-vamping your policy to fit the times. We are surrounded on all sides by evidence as to the necessity of extending credit in order to create a respectable volume of sales—automobiles, radio, refrigerators, in fact almost anything costing over ten dollars is offered to the customer on terms to fit the buyer's purse. Such comparatively small items as tires and batteries are often sold on easy terms, and some automobile service stations are financing the cost of auto repairs. Now all of these dealers are not chumps, and it is highly doubtful that any would so freely offer credit if there was any chance of getting the cash.

The serviceman may feel that his business is different, and must be conducted on a strictly cash basis, but at the same time almost any repair man can recall a number of jobs that were lost because the estimated repair bill was simply too much for the customer's pocketbook. To the average American family in ordinary circumstances, an unexpected radio repair bill of ten dollars or more would be a minor calamity, which could not be easily met out of any one week's income. Many radio men more or less recognize this factor, and have perhaps unconsciously allowed themselves to drift into a policy of trying to keep their estimates down to a price they feel the customer can pay. This usually results in a number of cheap makeshift repair jobs, with small profit to the serviceman, and the ultimate dissatisfaction of the customer, who becomes disgusted with a receiver that is never quite right, and changes servicemen, or buys a new receiver,—on time!

Too often the serviceman inspects a ten-year-old receiver that is in need of a general overhauling, and mentions a probable repair cost of \$20 in a manner that infers it is more than the receiver is worth, feeling that the customer cannot pay that much anyhow. The fact that similar receivers can be bought second-hand for five or ten dollars has nothing to do with the cost of repairing this particular set, and besides the customer may feel that the second-hand set cannot be much good, if it is going to cost twenty to clean up his receiver. The customer's set may have cost originally \$200, and quite often, as far as he is concerned it is still a \$200 receiver, and a repair bill of \$20 may not seem as excessive to him as the serviceman thinks. Generally the only fly in the ointment is the fact that he hasn't got \$20 to spend on the job. It will pay the serviceman to take a little time to find out what is holding the customer back, and if it is determined that it is lack of ready cash, then the offer can be made to split the bill to suit the customer's income.

Of course, it goes without saying
(Continued on page 42)



by WILLIAM T. PETERSON

Illinois State Police Dept.

THIS column is introduced in RADIO News for the sole purpose of supplying its readers with new developments and activities in the police radio field.

It is our desire to discuss the latest trends in the field, to present new circuit designs and equipment, and to provide items of general interest, both technical and non-technical to the several thousand engineers and operators engaged in police radio communication.

During the past few years, police radio has developed into one of our most necessary communication systems. The installation of several hundred police radio stations per year is definite proof that all civic minded groups are becoming aware of the increased efficiency a radio system offers to their police department.

The instantaneous despatching of patrol cars to accident scenes; the speed with which cars may be sent to various intersections to form a blockade; and the possibility of notifying all surrounding cars and stations of a crime the moment after it happens, are only a few of the advantages that a police radio system affords.

Indeed, it may be well spoken, to say that no other communication system in the world is performing such a humanitarian service for the benefit of mankind, as police radio.

FM Mobile Design

NOW that FM mobile transmitters and receivers are being placed on the market, we believe the first improvement the FM manufacturers could work out is to try to whittle down the size. The rigs we have seen are very beautiful, but they take up half the trunk compartment.

There is a lot of equipment that police cars store in that back trunk. With flares, stretchers, first aid kits and the like, very little room is left for radio gear.

The best we've seen, as far as serviceability and size is concerned is the new *Doolittle* Mobile FM and AM housing. These rigs are really a serviceman's delight. The housing is long and narrow. The front panel is only about 9 x 8 inches, and by releasing two knurled knobs, the chassis pulls out frontwards. The top, back and sides are blank, and the units can be placed side by side or one on top of the other.

In emergency cases, police sets must be serviced with great speed. Accessibility and compactness are vital factors in eliminating unnecessary service delays.

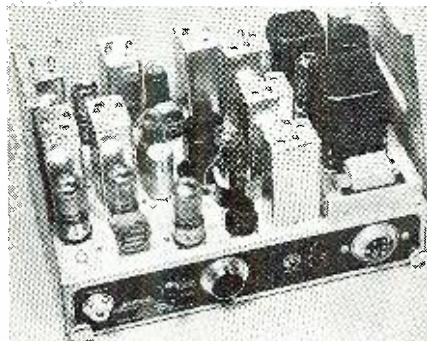

The Motorola FM Police receiver.

New Type Squelch

A NEW type of squelch circuit of FM receivers has been developed by Prof. Daniel E. Noble, pioneer FM engineer now Research Director at *Galvin Manufacturing Company*, Chicago, makers of *Motorola* radio equipment. This new squelch appears in the line of *Motorola* FM receivers.

Under test, this squelch circuit will open on a signal of .1 microvolt, offering a high degree of discrimination against noise impulses.

Another feature of the new FM receiver is an improved limiter action. Even though the signal may be slightly detuned in the receiver, an input signal of .4 microvolt will reduce tube hiss and noise fluctuation by a factor of 20DB.

A relatively high gain is essential for this remarkable limiter action in the presence of a very weak carrier. By the use of high gain tubes, the product of stage gain of this receiver is something over 300 million times, enabling the limiter to be completely saturated with only fractional microvolt input signals.

The circuit design of this receiver is a double conversion superheterodyne with two crystal controlled oscillators for maximum stability. It has a total of thirteen tubes less the power supply. The usual audio filter to cut off below 500 and above 3000 cycles is employed.

Tabulations

RECENT tabulations of the FCC list of police radio stations reveal there are 881 municipal fixed police radio stations licensed with 136 additional municipal portable and portable mobile stations, the municipal mobile stations numbered at the last available records was 3,542. The FCC has also issued 67 construction permits for other municipal fixed, portable, and portable mobile stations.

California leads the states in the number of municipal fixed stations with a total of 92. They also have 8 construction permits which will net them 100 stations!

Running a close second is New Jersey with 81 fixed stations and 7 C.P.'s.

(Continued on page 58)



"Hurry up and put it together again. Here comes the Captain to inspect!"

SOUND MAXIMUM PERFORMANCE

by **CLARK E. JACKSON**

New York City, N. Y.

A discussion on a timely subject for all P. A. men who might want to alter their equipment.

THE sound man and the amateur who builds his own amplifier equipment is often confronted with the problem of determining the correct means for the feeding of various sound sources, such as microphones and pickups, to either new or existing units. The manufacturers that turn out amplifiers at popular prices do not, in every case, pay much attention to these input stages due to cost limitations.

There are many ways in which we may improve upon conventional equipment from the standpoint of all-round performance. One of these is to select tubes that are free from microphonics or tube noise. Another is to use the newer "single-ended" tubes, such as a 6SJ7 in place of the older 6J7 which has its grid connection terminated to a grip cap on top of the tube. Obviously, this calls for a rather long grid lead connection from the input connector to the grid. If the lead is not completely shielded there will be considerable hum pickup from the exposed surfaces of the wire to stray fields. The 6SJ7 has the grid connection at the bottom of the tube along with the other elements. Additional shielding may be had by using the new *Millen* tube base shields which have been designed especially for such applications. They are mounted in such a position as to isolate the grid circuits from the plate circuits, and in turn, prevent any coupling between the two.

Next in line for discussion is the

may be achieved by using some form of fixed battery bias.

Inasmuch as the input tube operates strictly as a class A amplifier, there will be no current flowing in the grid circuit. We can, under this condition, use a miniature battery to supply the required bias. The life of this battery will be equal to its normal shelf life as no current flows through the cell. We may gain much greater advantage by using a unit known as a *Mallory bias cell*. This resembles, in appearance, a small acorn which is mounted in a special holder. The cell is available in either 1 volt, or in 1 1/4 volt potentials. The use of these little cells is the an-

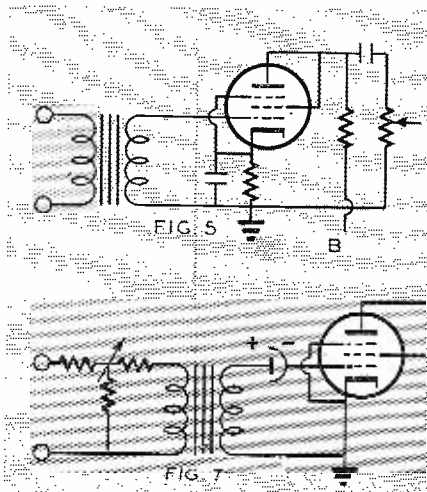
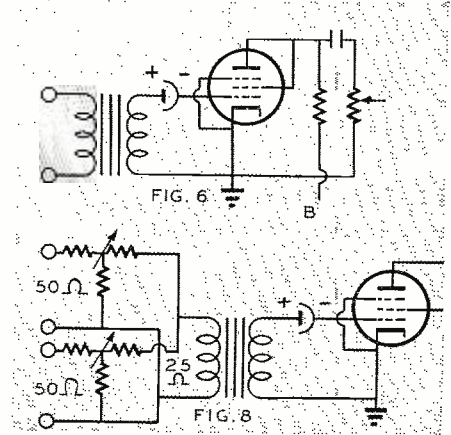

cuit is concerned but would not offset the tendency for the resistors to pick up the stray hum.

Fig. 3 is the next step in improving the performance of the stage. Here the cathode is at ground potential, and the bias cell placed in the grid resistor return at the ground end. The use of a 6SJ7 tube is recommended for use with this circuit. Another way for adding a bias cell to existing amplifiers is shown in Fig. 4. It is only necessary to ground the cathode and to add the bias cell right at the grid connection to the tube. Be sure that the grid lead is completely shielded right up to the tube pin.

Many amateurs overlook the necessity for proper shielding of high-gain circuits such as these. If ordinary jacks are used for input connectors, it is necessary to enclose the entire assembly within a metal can of some sort. The shielded wire lead should pass through a hole drilled at the rear of the enclosed can and soldered around the edges of the hole. This will reduce the tendency for the grid circuit to pick up any hum from outside sources. The advantages to the amateur operator are even greater as the complete shielding will, in most cases, eliminate the radio frequency carrier of the transmitter from getting into the speech equipment.

Mixer Circuits

Next comes the problem of proper mixing of various inputs to the ampli-

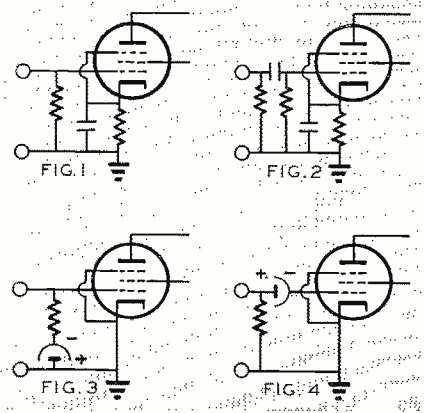
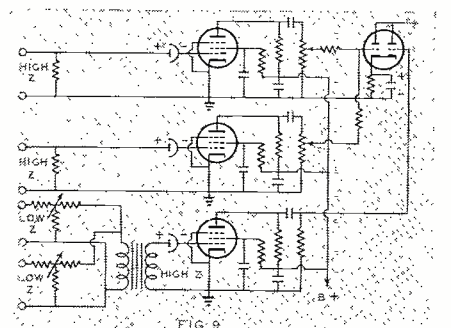

swer to the bias problem.

The next portion of the circuit to consider is the means used to feed the source to the grid of the input tube. Most manufacturers specify the correct load resistance for their particular product. This value should be used whenever possible. Fortunately there is an average for most units, such as crystal mikes or crystal pickups, and we may insert a resistor which will not upset the characteristics for different ones used: Fig. 1 illustrates a typical input circuit as used on the inexpensive type of amplifier. The grid load resistor is, usually, somewhere in the vicinity of 2 megohms. This is suited to most crystal mikes for satisfactory range. However, there are some instances where the response can be improved on by increasing this to 5 or 10 megohms.

Fig. 2 shows how the input shunt resistor may be of some value higher or lower than that of the grid resistor. A coupling condenser is used to isolate the two. This method is not recommended as it increases the possibility of hum pickup in the grid circuit unless the entire assembly and wires are completely shielded. A bias cell would offer some help as far as the grid cir-

elimination of cathode hum. This is caused by the characteristic of the tube, cathode bias resistor, and the presence of a heavy by-pass condenser across this resistor. If we can operate the tube with its cathode grounded there will be little chance to encounter hum-modulation from the a.c. filament supply. We must then find a substitute for the automatic bias, normally supplied by the cathode resistor. This

fier. Too often is this subject skipped-over as being non-important to the average layman. The music lover is no longer satisfied with just ordinary reproduction, nor is the successful PA operator satisfied with the older

(Continued on page 60)

BUY DIRECT FROM THE MANUFACTURER AND SAVE

WE KNOW OUR PRICES ARE VERY LOW and expect a certain amount of skepticism from servicemen who have never purchased the SUPERIOR way, but five years of sticking to our way of doing business has convinced us and many thousands of servicemen who have purchased from us that it is a practical and mutually profitable way of doing business. We know that the average income of the Radio Serviceman prohibits his purchasing high-priced equipment, and yet the very nature of his work makes it necessary for him to use accurate, dependable and up-to-date equipment. We know we have solved the problem for him and our continually expanding business proves that servicemen recognize this claim to be true.

BESIDES THE THOUSANDS OF SERVICEMEN AND TECHNICIANS, THE FOLLOWING WELL-KNOWN NAMES ARE LISTED AMONG SUPERIOR INSTRUMENT PURCHASERS: Standard Oil Company of New Jersey; U. S. Dept. of Agriculture; U. S. Dept. of Commerce; U. S. War Department; C.C.C. Camps; National Youth Administration; Goodyear Tire and Rubber Co.; E. I. duPont de Nemours & Co.; University of Nebraska; Leland Stanford Junior University; Westminster College; Oberlin College; University of Michigan; Boston College; Pomona College; Board of Education, Remus, Michigan; Board of Education, City of New York; Board of Vocational Education, State of Illinois; City of Bartow, Florida; Florida State Dept. of Education; Educational Dept., Custer, North Dakota.



The New Model 1220
POCKET LABORATORY
★ WEIGHS ONLY 28 OUNCES!!
★ USES a 2% ACCURATE 0-200 MICROAMMETER—ENABLING MEASUREMENTS AT
5000 OHMS PER VOLT
SPECIFICATIONS

- ★ 6 D.C. Voltage Ranges: 0-3-10-50-250-500-5,000 volts.
- ★ 3 A.C. Voltage Ranges: 0-15-150-1,500 volts.
- ★ 4 Resistance Ranges: 0-3000 ohms, with 15 ohm center, direct reading to 0.2 ohm; foregoing base range multiplied by 10, by 100 and by 1,000, to read up to 3 Meg. with self-contained 3 V. flashlight battery.
- ★ D.C. Current Ranges: 0-200 microamperes; 0-2-20-200 Milliampers, using wire-wound shunts.
- ★ 3 Output Meter Ranges: Same as A.C. Voltage Ranges.
- ★ 3 Decibel Ranges: From -2 to -58 D.B., based on .006 watt in 500 ohms.

Model 1220 comes complete with cover, self-contained battery, test leads and instructions. ONLY **\$10⁴⁵**

THE NEW CHANNEL-ANALYZER

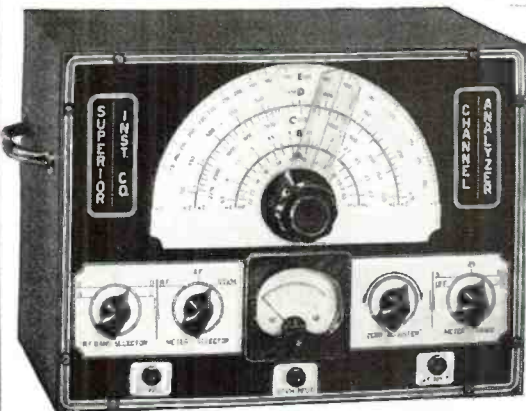

FOLLOWS THE SIGNAL FROM ANTENNA TO SPEAKER OF ANY SET

The well-established and authentic SIGNAL TRACING METHOD of locating the very circuit in which there is trouble, and the very component that causes the trouble, is now for the first time available at a price any radio serviceman can afford.

THE CHANNEL-ANALYZER WILL

- ★ Follow the signal from antenna to speaker through all stages of any receiver ever made.
- ★ Instantly track down exact cause of intermittent operation.
- ★ Measure both Automatic-Volume-Control and Automatic-Frequency-Control, voltages and circuits without appreciably loading the circuit, using built-in highly sensitive Vacuum-Tube Voltmeter.
- ★ Check exact gain of every individual stage in receiver.
- ★ Track down and locate cause of distortion in R.F., I.F., and A.F. amplifier.
- ★ Check exact operating voltage of each tube.
- ★ Locate leaky condensers and all high-resistance shorts, also show opens.
- ★ Measure exact frequencies, amount of drift and comparative output of oscillators in superhets.
- ★ Track down exact cause of noise.

The Superior Channel-Analyzer comes housed in shielded cabinet and features an attractive etched aluminum panel. Supplied complete with tubes, three specially engineered shielded input cables, each identified as to its purpose. Also full operating instructions. Size 12" x 10" x 6". Shipping weight 19 pounds. ONLY **\$19⁷⁵**

The New Model 1240 TUBE TESTER

Instantaneous snap switches reduce actual testing time to absolute minimum. Tests all tubes 1.4 to 117 volts.

Sockets for all tubes—No adapters.

SPECIFICATIONS:

- ★ Tests all tubes, 1.4 to 117 volts, including 4, 5, 6, 7, 7L, octals, octals, Bantam, Jr., Peanut, single ended, floating filament, Mercury Vapor Rectifiers, the new S series, in fact every tube designed to date.
 - ★ Spare socket included on front panel for any future tubes.
 - ★ Tests by the well-established emission method for tube quality, directly read on the GOOD ? BAD scale of the meter.
 - ★ Jewel protected neon.
 - ★ Tests shorts and leakages up to 2 megohms in all tubes.
 - ★ Tests leakages and shorts in all elements AGAINST all elements in all tubes.
 - ★ Tests BOTH plates in rectifiers.
 - ★ Tests individual sections such as diodes, triodes, pentodes, etc., in multi-purpose tubes.
 - ★ Latest type voltage regulator.
 - ★ Features an attractive etched aluminum panel.
 - ★ Works on 90 to 125 volts 60 cycles A.C.
 - ★ Model 1240 comes complete with instructions and tabular data for every known type of receiving tube. Shipping weight 12 pounds. Size 6" x 7 1/2" x 10 3/4".
- Our Net Price **\$11⁸⁵**
PORTABLE COVER \$1.00 ADDITIONAL



MODEL 1230 SIGNAL GENERATOR

WITH FIVE STEPS OF SINE-WAVE AUDIO

SPECIFICATIONS:

1. Combination R.F. and A.F. Signal Generator. R.F.—100 K.C. to 90 Megacycles. A.F.—200 to 7500 cycles; Sine-Wave.—WITH OUTPUT OF OVER 1 VOLT. All direct reading, all by front panel switch manipulation.
2. R.F. and A.F. output independently obtainable, alone or with A.F. (any frequency) modulating R.F.
3. Latest design full-range attenuator used for controlling either the pure or modulated R.F.
4. Accuracy is within 1% on I.F. and broadcast bands; 2% on higher frequencies.
5. Giant dial etched directly on front panel, using a new mechanically perfected drive for perfect vernier control.
6. Operates on 90 to 130 V. A.C. or D.C. (any frequency).

The Model 1230 comes complete with tubes, shielded cables, molded carrying handle and instructions. Size 14" x 6" x 11". Shipping weight 15 pounds. ONLY **\$12⁸⁵**

SUPERIOR INSTRUMENTS CO. 136 Liberty St., Dept. RN3 New York, N. Y.

TECHNICAL BOOK & BULLETIN REVIEW

THE METER AT WORK. *John F. Rider Publisher*, of 404 Fourth Avenue, New York City, has just released a new book on a subject of interest and importance to the Radio Serviceman. This volume presents facts on "The Meter at Work" in the typical *Rider* manner. In it the reader finds how each type of meter works—how it is used—how to get the most from the meters he now owns—and what factors to consider in the selection of new ones.

With a knowledge of the principles underlying his present instruments, the serviceman can get the utmost help from them. "The Meter at Work" explains the theory upon which each type of meter is based—explains the theory complete in itself—while all the facts about each type are together. The practical applications are covered in the latter portion of the book. The following chapter heads show how the reader can, without lost motion, cover any phase of the subject in which he is interested—the theory—the characteristics—or the practical work.

Chapter 1—General Considerations. 2—Moving-Iron Meters. 3—Moving-Coil Meters. 4—Electrodynamic Meters. 5—Electrostatic Meters. 6—Thermal Meters. 7—Components of Meters. 8—Characteristics of Meters. 9—Rectifiers and Thermocouples. 10—Practical Applications.

In addition to the valuable text material, "The Meter at Work" features a new and novel *physical* make-up. The inside pages of this new book are split so that the top parts (containing the illustrations only) are separate from the bottom parts (containing the text). Thus the text pages can be turned without disturbing the illustrations—and vice versa. This new make-up eliminates the necessity of constantly turning pages back and forth to consult illustrations while reading the text matter describing them. This publishing innovation Makes Reading and Learning, Simple and Easy.

"The Meter at Work" has 152 pages and 138 illustrations—is now available at parts jobbers and priced at only \$1.25.

MOST POPULAR 1940 RADIO DIAGRAMS. Published by Supreme Publications, 3727 West 13th Street, Chicago, Illinois. This new manual gives you over 80% of all 1940 circuits to completely describe the modern receiver. Furthermore, it acquaints the reader with recent radio developments and teaches him how to service quickly and efficiently the millions of sets that were sold last year. Includes service information, repair hints, alignment dope, and parts lists on the new portables, television, frequency modulation, signal tracing, amplifiers, inter-desk communicators, recording, etc. Book contains 212 pages, 8½x11 inches. Price \$1.50.

LAFAYETTE RADIO CATALOG No. 82. Just off the presses is this new radio parts catalog including a host of new items for the serviceman. (Continued on page 66)

MANUFACTURERS' LITERATURE

Our readers are asked to write directly to the manufacturer for this literature. By mentioning RADIO NEWS and the issue and page, we are sure the reader will get fine service. Enclose the proper sum requested when it is indicated.

ASTATIC MICROPHONES and PICKUPS, Catalog No. 40 and 40B, is now available to persons interested in a most complete line of phonograph pickups for all applications. A feature of the *Astatic* line is the new "Feather Weight" low pressure pickup. This has a permanent sapphire stylus that will last indefinitely. There is practically no wear to the record as the pressure is kept to approximately one ounce. Far greater life will be had from both commercial and home recordings when this new pickup is used. The home recordist will gain even longer playing life in proportion. The catalog also lists many other pickups in both standard and in professional types.

A full line of crystal microphones for all purposes is illustrated. Included is the famous D-104 "speech-range" microphone, widely used by radio amateurs throughout the world. Free. *Astatic Microphone Labs*, Youngstown, Ohio.

EARL WEBBER RED BOOK for 1941. This new sheet contains a complete listing of all of the new Webber instruments for the new year. They include Model 200MM Dynamic tester, Model 150 Tube Tester, Series 200 Dynamic Tube Tester, Model 200 LC counter-type tester. A new type of instrument known as the Model 210 Service Estimator is illustrated. This combines two instruments in one. It is a combination DeLuxe tube tester and Volt-Ohm-Milliammeter built into one compact unit. It features high-range readings so that television sets may be serviced rapidly and accurately. A copy is available from the Earl Webber Co., 4348 W. Roosevelt Road, Chicago, Ill. Free.

RCA SERVICE NOTES. The largest and most complete bound volume of service notes ever issued by *RCA Victor*, covering all 1939 radio and radio-phonograph instruments and a number of 1940 models, has been made available for dealers and servicemen. The 480-page book, including more than 500 illustrations, has a net price to Service Dealers of \$1.50. It is available from *RCA-Victor Co.*, Camden, N. J.

More than 150 circuits are shown with schematic diagrams, or nearly double the number included in the 1938 edition. The volume also includes complete instruction books on new *RCA* test equipment, a new index for all bound *RCA Victor* service notes, and a special supplementary data section for receiver and equipment models covered in the 1939 and preceding volumes.

All service information is presented in the original, unabridged form, including complete alignment data. The volume also includes television service notes on the latest type receivers. The test equipment instruction-service notes cover such up-to-the-minute instruments as the Signalyst, Volt-Ohmist, Five-inch CRO, Television Sweep Oscillator, Crystal Calibrator, and Tube Tester. In addition, one of the most valuable inclusions in the bound volume is the 48-page new edition of the famous *RCA Rider Channelyst* instruction book. These notes themselves represent a storehouse of practical technical information on radio testing methods. Price \$1.50.

STANCOR HAMANUAL. The Fifth Edition *Hamanual* has just been announced by the *Standard Transformer Corporation*. This is a 48-page, two-color catalog which describes completely, twelve different transmitters and six amplifiers. A complete circuit is given on each unit in blueprint form. All the component parts lists are shown, together with the original manufacturers' part numbers.

This year for the first time a complete array of power supply kits is offered. Too, the kits are all guaranteed by *Stancor*.

Many other new features are incorporated in the book, which this year has had an unprecedented advance sale.

The *Hamanual* is available either from the *Stancor* distributor or direct from the factory at 15 cents net.

The name "Hamanual" was originated by the Managing Editor of *RADIO NEWS*. Price 15c. at *Standard Transformer Corp.*, 1500 N. Halsted St., Chicago, Ill.

NEW C-D RADIO CAPACITOR CATALOG. Just off the presses is the *Cornell-Dubilier* 1941 Radio Capacitor Bulletin No. 185A in which are listed and illustrated all types of capacitors for radio applications, including mica, paper, wet and dry electrolytics, Dykanol, etc. Complete information on each type includes full ratings, sizes with dimensional drawings, and prices. All items are classified and arranged for accurate and speedy reference.

Copies of this new bulletin may be obtained from dealers everywhere, or by writing direct to *Cornell-Dubilier Electric Corporation*, South Plainfield, N. J. Free.

MODEL CE and A. C. MOTOR STARTING CAPACITORS. Two folders recently released by *Solar Manufacturing*. (Continued on page 66)

THE VIDEO REPORTER

by Samuel Kaufman

IT'S been customary for each item in the *Video Reporter* column to begin with a big capital letter. That's the make-up style of this magazine and it's a thing we've become accustomed to. Yet, looking back at the column in the January issue, it suddenly dawned on us that the first two items, leading off as usual with big initials, told an unintentional exclamatory story. The first item had a big black "A" and the second one had a large ebony "W". Put them together at a single glance and they spell "Aw!"

Now the word "Aw!" is an exclamation that may, at this point, call for an explanation. That is, an explanation of why it stood out so boldly to our eyes.

Well, the answer is simple. We believe that the expression just about sums up our opinion of television's progress in 1940.

When 1940 made its exit, it was not merely the end of a year. It was also the end of a decade. Further, it was the end of radio's second decade. So it was an important milestone.

It was a year of great promise for television and it was a promise that was *unfulfilled*. But, mind you, it was not a broken promise. But somehow, it's taking more time than anticipated for commercial sight-and-sound broadcasting to gain a foothold. The only consolation is that the trade and industry did its part in furthering things. The main hurdle too difficult to clear in 1940 was winning the confidence of the *Federal Communications Commission* to the point of getting a commercial grant for video stations. But there was delay, delay and more delay, until an entire year passed. And, it must be added that disputes over standards and frequencies in the trade itself was a hampering factor and that this point alone was sufficient for the *FCC* to demand a delay.

ACTUALLY, as 1941 came tearing around the bend, the signal of the video industry seemed to be full speed ahead. But it was still on a single track course which meant limited speed in progress. But progress was obvious. Even the *FCC* action in requesting a delay to iron out standards may prove constructive in the long run.

The most disillusioning thing of the video industry's status as 1940 bowed out was a lackadaisical attitude prevailing in network offices regarding television. Even where there were great fires of enthusiasm in previous months, there was barely a spark in December and early January. And it seems that the only reason they cared to nurse the spark along was that a great investment was represented in getting it started and that no one cares to put up great sums of money for enthusiasm flint until there are signs of early commercial profit.

TAKE the network, for example, where the greatest amount of television ballyhoo to date originated. Mention the word "television" around its offices today and there's a look of sadness rather than one of enthusiasm. It seems as if something is being mourned rather than sponsored. But the lads in the network's office declare that the lack of spirit is not their fault but that everything must await the action of the *National Television Systems Committee* and the more important reaction of the *FCC* before anything constructive can really be started or resumed.

Skeleton staffs and skeleton programs are maintained where even a year before the network was going at things in a big way on a big budget. And when you deal with skeletons you deal with decay and, unless something comes along quickly to yank the video spirit out of the doldrums, it will bring television to the paradoxical state of being deca-

(Continued on page 64)

For Ideal HOME RECORDING



INSIST ON MEISSNER QUALITY!

Engineered for truly superior performance—utmost fidelity in recording—most life-like quality in reproduction—this "different" Meissner Phono-Recorder, in portable form, is designed for those who want nothing but the best—at reasonable cost!

Outstanding in appearance—motor board and arms finished in dark brown crystalline lacquer—panel plates in two-toned etched brass—modern, airplane-luggage styled case with antique bronze fittings—sturdy, all-leather handle—a professionally artistic ensemble!

Complete—ready for use—5-tube built-in amplifier with 6 watts output—may be used as Public Address unit! Includes "hand-or-stand" crystal microphone—mike and power cord pack into space beneath panel plate on right. Uses powerful magnetic cutting head and highest grade crystal pick-up. Handles any record up to 12-inch; ample storage space in removable cover. For 110-volt, 60-cycle operation.

Model 9-1045 Portable Phono Recorder, Complete. List, \$59.50

MOTOR TURNTABLE UNIT

A complete dual-arm mechanism of highest quality for use in any installation. Similar to unit used on Phono-Recorder above; has powerful, constant-speed motor for 110-volt, 60-cycle operation. Heavy steel base; all metal parts finished in brown crystal lacquer.

Magnetic cutting head is low impedance—connects to voice-coil secondary of output transformer. Crystal pick-up is high-impedance type. Accurate, worm-gear mechanism controls traverse of record by recorder arm.

No. 9-1039 Turntable Unit. List, \$31.50

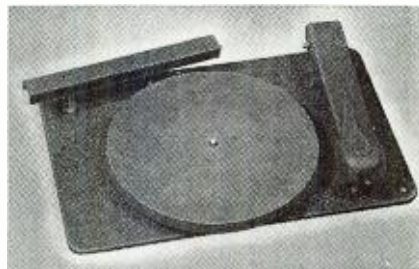

Write for Your Free Copy of the New Meissner General Catalog!

ADDRESS DEPT. N-3

RADIO PHYSICS COURSE

by Alfred A. Ghirardi

A receiver that delivers a perfectly undistorted signal is one which has a uniform or flat frequency response curve from antenna to loud speaker output. This considers the loud speaker as part of the receiving equipment—which it most certainly is. Of course, this assumes that the equipment in the broadcasting station does not cause any distortion. In modern, high-class stations, this is so nearly true that we may assume that their output is perfectly undistorted. Most transmitters now being constructed have an audio frequency range of 30 to 10,000 cycles with very small deviation from uniform frequency amplification over this range. While receivers which are perfect as regards the above three considerations, are practically impossible to attain in practice, many present day receivers are so sensitive, selective and produce such excellent frequency response (the average ear would not detect the small distortion present) that very satisfactory performance is obtained.

We have already studied the factors which affect the energy radiated from the antenna of the transmitting station. We found that since this energy spreads out over a large area in all directions, the amount available at any receiving antenna to set up voltage in it is extremely small even when the transmitting station is only a few miles distant. In order to compare the strengths of the signals received from various stations and the sensitivity of various types of receivers, it has become a practice to call the *voltage* that is induced in the receiving antenna, the *field strength* of the transmitter at that particular point on the earth's surface. The voltage set up in the average antenna is usually a few thousandths of a volt (millivolt). Since the voltage induced in a higher antenna will be greater than that set up in a lower one, it has become standard practice to rate field strength as so many *microvolts per meter*, or so many *millivolts per meter*. Microvolts is commonly used, because the e. m. f. induced in an antenna is so small, that the use of the volt as a unit would necessitate the use of decimals in most cases. Thus, an antenna having an effective height of one meter, (1 meter is slightly over 3 feet) and having 10 microvolts induced in it is located in a field strength of 10 microvolts per meter. An antenna 5 meters high and having a voltage of 10 microvolts induced in it, is situated in a field of strength of 10 divided by 5, or 2 microvolts per meter, etc. The *effective height* of an antenna bears little relation to the actual height in meters of the antenna. It depends on many things—how well the antenna is insulated, the kind of soil over which it is erected, etc. The effective height of an antenna is somewhat less than its actual physical height above the ground and in most receiving measurements it is assumed as an average of 4 meters (13 feet). Of course the greater the field strength existing at the location of the receiving antenna, the more the volume one can get out of a receiver. —30—

For the Record

(Continued from page 4)

have come to the conclusion that in electronics lies a splendid future for those of our radiomen and servicemen who will prepare themselves with knowledge. The small amount of the matter covered by John should suffice to whet the appetite of these men to go further into the subject. We freely foretell that their efforts at self instruction in electronics will some day pay handsome dividends in a wider field within which to work. One of the main difficulties with radio as it is constituted today is the narrowness of the profession. The continuing advance of electronics into everyone's lives will provide the radioman and the serviceman with as wide a horizon as anyone could want. And that horizon is gold, if you will but seek it.

* * *

THE electron multipliers mentioned in the electronic article are the queerest things. Heretofore every radioman has guarded against "secondary emission" as a ne'er-do-well bugaboo of radio. Now here comes that same secondary emission and brings with it the promise that in one tube you will soon see the equivalent of 10 or even 20 tubes. With FM, that makes *two* former "discards" which are now forerunners of some mighty important developments in radio. Who knows which disadvantage of radio will next turn into a distinct step forward in the ever increasing use of the electron.

* * *

REPORTS reach us that the ham is not engaging in the further purchase of high powered transmitting equipment. This will be a sad story for those manufacturers whose *entire* line is in the 500-watts-and-better class. Fortunately, these are very few indeed. But to the ham game in general the decision of the fraternity to stick to low power will bring a much needed rest from the raucous 1-kw sigs which have heretofore prevented the little guy from doing any decent dx. Now, with fewer high powered boys on the air, local 48-state dx becomes a keenly competitive sport which will do much to disperse the annoyance caused by not being able to work the foreigners. We are still waiting for the ham to make WAS with one (1) watt (we really mean it) power input. We believe it can be done, if—and it's a big if—the rig is used with an unusually well-designed and constructed antenna. Yes, even on 160 meters it ought to be possible!

* * *

MANY of our drafted readers have written in complaining that whereas they have what they think to be sufficient qualifications for radio work in the Army that their requests for radio work have gone unheeded. Investigations were instituted in each individual case with the following fault found to be the most common. The persons told their Draft Boards that they were proficient in radio and *not* their Army board. As far as we are able to find out, after a man has been accepted by the local Draft Board, he is given a physical and medical examination. If he passes that, he is given a long and searching psy-

chological examination by an Army officer to determine the place best fitted for the draftee in Uncle Sam's Army. It is at this point that the prospective recruit should stress his radio knowledge and ask for assignment to radio duty. It will do very little good to tell the Draft Board about your radio qualifications since they have no control over the branch into which you might be inducted. Tell the Army Board, and we are confident that you will be given radio work to do.

One thing more. Army radio is vastly different from civilian radio. Do not make the common mistake of saying, "I know radio!" Say, instead, "I have some radio experience; can receive so-and-so-many words a minute in code. I think that I would make a good Army radioman. I should like to be assigned where I can *learn* more about radio and have a chance to use that which I already know." That attitude will almost always bring the desired result. If it does not, one can always apply for a transfer immediately after the "quarantine period" of the initial enlistment or appointment. Transfers are common in the Army, and anyone can usually get one, if sufficiently good reason exists therefore. Knowledge of radio has been considered such a reason.

* * *

AND that about winds up the column for another month. Soon we will have the June Radio show and nice summer breezes. Would that someone would invent a way to heat the air—with electrons—so as to make Chicago a Miami Beach these cold winter days and nights. KAK

—30—

Bench Notes

(Continued from page 37)

that when an extensive overhaul job of this kind is accepted, the serviceman is going to have to deliver the goods, in the way of competent first class service, and do something more than replace a by-pass or two, and blow the dust out of the tuning condenser. We have had an increasing number of such jobs in recent years, and find it desirable to make a detailed report, accompanied by a definite guarantee, usually specifically excepting any major components, such as the power transformer and speaker, if they are not replaced at the time.

There are admittedly drawbacks to this plan as there are to any other, but a man never does effect an ideal way of doing business. There is, of course, some inconvenience in doing business on credit, but it is a lot more inconvenient to be doing no business at all. Each month we note a respectable number of jobs taken in solely because credit was extended, with bills attached for higher totals than the average of cash jobs. Only in a few cases is it necessary to extend the payments for more than a few weeks. For example, just today we brought in an old Majestic combination, which, the owner rather indignantly informed us, his *former* serviceman had told him was not worth fixing. We have set a tentative repair price of \$25 to \$30 on this job; \$10.00 to be paid on delivery and the balance split two ways and due on the 1st and 15th of the month. We think we can afford to wait this long for our money!

Radio Battle of 1941

(Continued from page 7)

let it be known publicly that he had perfected the Frequency Modulation method of broadcasting. He said he regarded it as the most important invention of his career—more significant than his invention of the regenerative, feed-back circuit, which made modern broadcasting possible.

At that time, Major Armstrong went to RCA with his invention and sought to interest them. He was a large stockholder in the company, by virtue of his earlier patents, and sought to sell them on the future of FM. They allowed him to use a television transmitter on the Empire State building for experiments which lasted a year.

Then they turned down the FM idea and told the Major they needed their transmitter back. Reportedly, President David Sarnoff of RCA looked with favor on FM, but his advisors talked him out of it. At any rate, Major Armstrong, embittered, vowed to do the job himself. With the money he had and was earning from his RCA stock, he began to build the broadcasting method which he hoped would upset the Amplitude Modulation applecart—including RCA.

He enlisted the support of Carman Runyon, a Yonkers, New York, coal merchant and amateur radio operator, and they continued work from Runyon's small station. In 1935, Major Armstrong went before the FCC to obtain permission to build a big station. The FCC looked down its nose at FM—but one engineer who heard Major Armstrong's arguments did not. He was Paul de Mars, of the Yankee Network in New England. He brought the inventor together with John Shepard III, who was head of that network.

Shepard was converted to the FM idea and built a powerful transmitter outside of Paxton, Mass. Soon, others followed in the experimental work on the new static-less, high-fidelity broadcasting. Last spring, the experimenters—banded together now as FM Broadcasters, Inc., marched to Washington to demand from the FCC the right to go on the air as commercial rivals of the powerful AM chains.

Up until this time, the FM system had been largely an engineering proposition in the minds of the FCC. The Commissioners are almost all laymen, with little knowledge of the technical side of radio. The membership of the Commission is predominately New Deal and the Commissioners had been doing battle with the big-business broadcasting chains—without any singular success.

When the FM Broadcasters began to unveil their creation, the Commission began to beam. For they saw the possibility of getting the big chains where they wanted them. The noise-free, high-fidelity qualities of FM were very nice—but the system had implications which went far beyond that.

This is one of the least understood aspects of FM broadcasting, and it is the crux of the current situation. FM is important not so much because it would bring about a complete change in the engineering standards of radio—but because it would change entirely the economics of the radio industry.

The present AM broadcast band "just grew." No well-planned system was established for allocating frequen-

cies. The band became crowded and it became apparent long ago that there would be room for only a limited number of stations. Thus, an artificial restraint was placed upon the growth of broadcasting. There was not the question of how many stations the public would support—but how many there was room for.

Thus, the stations which grabbed off the first and best spots and held on to them were riding a sure thing. They were safe from very much competition and could look forward to the enjoyment of years in the sun. This situation made the New Deal Commissioners very unhappy, because they believed there should be free economic competition and it was their idea that the lack of this competition had created a great broadcasting monopoly.

When they heard the story of FM,

they saw the answer to their problem. For FM would open an entire new broadcast band—which they could plan in their own way from the start. There would be room in this band for as many stations as could make a go of it financially. The artificial restraint would be removed.

So the FCC decided to give FM the "green light." In the months that have passed, it has become apparent that the Commission gave FM a whole boulevard strung with green lights.

The Commission set aside for FM use the band from 42,000 to 50,000 kc. This lavish assignment meant that Television Channel No. 1, on which RCA was doing some experimental work, had to be moved. The RCA people objected, but they lost the round. In order to give FM the full accommodation, it was necessary for thousands of Government stations to shift



Type D UNIVERSAL Controls



STOP WASTING TIME ON VOLUME CONTROL REPLACEMENTS



FREE!

The 18 Type D Controls, 6 switches and 5 extra Tap-in Shafts, factory-packed in this IRC Master Radiotrician's Cabinet, handle from 60% to 75% of all control replacements. You pay only \$14.97 net—the standard price of the controls, switches and shafts. The Cabinet (of dust-proof, all-metal construction) is included at no extra cost. Ask your IRC jobber to show it to you or write for folder. It's a time-saving, money-saving development no serviceman will want to miss!

Stop wasting time by ordering a volume control every time you need one for a job! Stop wasting time puzzling how to fit a control with shaft attached into a crowded chassis without removing other parts! Stop wasting time waiting for a more costly "special" replacement, when a standard IRC Type D Universal Volume Control with a special Tap-in Shaft will turn the trick!

In short, use IRC Type D Controls with Tap-in Shafts *universally*. Learn how a stock of only 18 of these controls equips you for prompt service on about two-thirds of all types of replacements. Study the construction of these sturdy little controls and see how amazingly superior Type D's are to ordinary midgets—fully equal in quality to the larger Type C Controls and with all the same features *plus* the added convenience of Tap-in Shafts which make them far more universal in use and much easier to install in a crowded receiver. Catalog free.



Tap-in Shafts Stay Put!
Don't pull loose.
Don't vibrate loose.

INTERNATIONAL RESISTANCE CO. 401 N. BROAD ST., PHILADELPHIA, PA.

also. This they did, on the FCC's assurance that it was for the best, without a peep.

In the course of the hearing, there occurred an extremely interesting argument on one point. The FM people had asked that each of their channels be 200 kilocycles wide. In that way, they explained, there was plenty of room for swing—which assured the high quality of FM reception.

The RCA position was that 75 kilocycles was wide enough for an FM channel. If the Commission established the channels at that width, the RCA men pointed out, it would not be necessary to move the television channel. The FM broadcasters contended that if they were limited to 75 kilocycles, their stuff wouldn't sound any better than AM broadcasts. It was only on 200 kilocycle widths that FM really worked. Furthermore, it was charged, the RCA men knew this very well. They knew that if they held FM to 75 channels that its effectiveness would be ruined and the whole system would be choked on the spot.

Columbia Broadcasting took no active part in the hearings, but through counsel introduced a statement upholding the RCA argument. There was a crisis here. But the FCC took its stand with the FM broadcasters. It said the channels would be 200 kilocycles wide, for the time being anyway. Later, if it deemed the move advisable, the Commission could reduce the bands to 75. Don't forget that—it gets important later on.

The FCC praised FM to the skies in its report. In the months that followed, it put out a blizzard of press releases and public notices on FM. In November, the Commission went far out of its way to call an engineering conference to discuss standards of transmitting stations for FM broadcasting. This action, which a statement from the FCC admitted "it would not ordinarily be concerned with," was taken to speed up the production of FM equipment.

There came more press releases, noting the establishment of new FM stations and commenting on the areas served. The experimental licenses, due to expire January 1, were extended for 60 days. The FCC was for FM, heart and soul. There could be no doubt of it.

While offering its arm to the FM broadcasters, the agile Commissioners were dealing out kicks in the shins to the AM chains. The monopoly report, prepared after a long study, hinted at dire things. The chains, it was apparent, were on the hot spot.

At this point, they find themselves faced with a situation which may, before long, become acute. They are at war with a hostile Commission, allied with an aggressive band of broadcasters, who are the possessors of a product which in many ways is undoubtedly superior.

The AM broadcasters are possessors of licenses which are good as gold, now. They are practically immune to competition from any new sources—in the AM band. If they abandon the AM band, they are forfeiting their security. If they stick to it, they may miss the boat on FM, if it catches the public fancy. They must face the possibility that hostile FCC activities will impede them, or that a war may come along and sweep them completely off the frequencies they now use.

So far, their fight to retain their empire has been defensive. There are indications that they are getting ready to become a little more aggressive, however. The AM broadcasters have been ignoring the FM blows—publicly. Their strategy is apparent.

The AM broadcasters have the field now—the equipment, the talent, the advertisers and the listeners. As long as the FM broadcasters have none of these, the AM chains don't have to worry. Columbia is participating in this grand strategy of "blockade," too. It recently barred its program from rebroadcast on FM stations.

But this situation cannot obtain indefinitely. The FM broadcasters have got some fighting men in their ranks. These men are working to effectuate a national chain of their own.

Who are these men who may be in the process of biting off a hunk of the empire of the air? The top man in FM is John Shepard. His name is mentioned almost in reverential tones around the FCC. He is a business man who controls a going thing in the Yankee network. His area, where natural and man-made interference is a serious problem, would benefit more by FM than any other part of the country, probably.

There is Walter J. Damm, of the Milwaukee Journal, Herb Petty, of Loew's; Louis Allen Weiss of the Don Lee chain in California; Paul Morency of Hartford, Conn.; Gene McDonald of Zenith, in Chicago; E. H. Scott of Scott Radio Laboratories, Chicago—there are half a hundred of them, mostly well-established and mostly yelling for blood.

The AM chains have foreseen the possibility of the formation of an FM chain, which may have the equipment and the talent. But, the strategists have ruled, the chain will never get any advertisers until it gets some listeners. And it can't get listeners until it gets some sets that will receive FM.

Now who's going to make the sets? Here the "ignore them and maybe they'll go away" strategy was applied again. RCA made no effort to begin the manufacture of FM receiving equipment. But it hasn't worked out so well.

For the FM broadcasters had enlisted the support of some manufacturers. Ray Manson, of Stromberg-Carlson, was one of their broadcasters. Irving Reed Wier, of General Electric, got his company making sets. GE is bringing out a converter, which can be hooked up to an AM set so that it will receive FM, to sell for \$50.

[Some of those who have joined the FM bandwagon are: *Hallcrafters and Scott of Chicago; Meissner of Mt. Carmel, Illinois, and Browning of Winchester, Mass. All are making FM receivers in one form or another.—Ed.*]

And jumping on the bandwagon with a Comanche yell comes Comdr. McDonald and the Zenith manufacturing outfit. McDonald is betting FM across the board. He is backing a station and is going to turn out FM sets faster than anyone suspects. He knows the dilemma that the AM broadcasters and manufacturers face—and figures to catch them napping.

At this point, then, we can see that the FM broadcasters aren't just going to be ignored away. The AM outfits have seen that the country's estimated four billion dollars investment in radio is at stake.

There are supposed to be more than 40,000,000 receiving sets in America, not to mention the auto-radios,—in which the public has invested over \$3,000,000,000. The AM broadcasters have sunk more than \$75,000,000 in their equipment and the Government and other agencies have more millions tied up in it. The three chains had net earnings of in excess of \$60,000,000 last year. That ain't hay. And there's no reason to believe that AM broadcasters or manufacturers are going to let any considerable part of it get away without a fight.

There is another organization which is in the middle. The A. T. & T. received in the neighborhood of \$10,000,000 last year from radio stations for use of its land lines. If FM cuts out the studio-to-transmitt line—by using direct transmission—or if it develops what Major Armstrong wants—an all-radio network—the A. T. & T. will lose a juicy slice of the melon. The A. T. & T. has offered to put in lines which will handle anything from 50 to 15,000 cycles for the FM broadcasters. They are asking a stiff price, however, and unless they come down they stand to lose the business if FM succeeds.

Now it is apparent at this point that the FM broadcasters are in a position to give the AM chains a battle. The FCC is intent on breaking the chains' hold on broadcasting. It wants to get the broadcasting industry on a new basis. If FM becomes universal, there will be no physical limit on the number of stations in one town. The interference problem is solved.

That means there will be two or three times as many radio stations in the United States. That means there will be more broadcasting chains and therefore more competition for the big ones. In the shuffle which would come with a shift from AM to FM, the FCC hopes that the big chains would lose their grip on the industry.

The FM broadcasters, because most of them are already in the business and are in a position to make money on their AM activities, can finance the infant through its early years. They have interested manufacturers who can put out the sets. There is no question but that FM broadcasters are in a position to menace AM's exclusive hold on the business.

Since this is true, and since we have seen the size of the stakes, we can get an idea of the battle that is being developed now. Washington is one of the main fronts of this battle. There are strange things in the wind.

Some strategists have urged that the President's influence be enlisted on the side of AM. After all, they argue, the radio—and they mention AM radio—has been instrumental in his success. He should feel some debt. These strategists would have the President pull the FCC off the chain's necks.

But, though the President may feel some obligation to the AM broadcasters and though he may not want to see the broadcasting industry juggled with in time of crisis, there is no evidence to show that he has taken sides. After all, he might have been re-elected by FM just as well as by AM.

In Congress, however, there is an opportunity for quicker action. The AM broadcasters can find some support there. It is obvious that they couldn't get very far buttonholing Congressmen with the complaint that somebody had invented a new kind of radio that was going to give them com-

petition. Things aren't done that directly in Washington.

The most logical *oblique* approach to the problem would be to stir up trouble for the FCC and encourage demands for an investigation. This could lead ultimately to some changes on the Commission, in the course of which those Commissioners who are "persecuting" the broadcasters would be disposed of.

By a coincidence, there have been outcries at the Capitol against the FCC. There is pending a resolution which calls for an investigation of the body, as well as of the radio industry. And last session, a Senate committee refused to confirm one of the business-busting Commissioners who came up for reappointment.

The resolution for the investigation was introduced by Senator Charles W. Tobey, who doesn't like the FCC nor the radio industry very well. It is reported that Senator Wallace White of Maine, a man well-informed on radio problems, has another such bill up his sleeve. If such a probe got under way, there would be Senators whose views were reasonably similar to the AM broadcasters.

[Senator Tobey's Resolution, S. Res. 20, carries with it wide powers of investigation. Directed to, and presently resting with the Interstate Commerce Commission, one of the Senate's most powerful bodies, it provides for an initial outlay of \$25,000 for the expenses of the investigation. It is believed that this sum was chosen at the low figure fixed to allay any suspicion of FCC adherents that the investigation would be sweeping. After all, the proponents

of the Resolution reasoned, who in the opposition believes that much of an investigation can be carried on with \$25,000. There is, however, nothing in the bill preventing the request for a greater appropriation later should the bill be passed and the investigation get under way.

How far-reaching the investigation might become can be seen from the terms of the Resolution which are here quoted. It provides that the Interstate Commerce Committee . . . "make a full and complete investigation with respect to (1) the existence, extent, formation, legality, and effect upon the public or any individual or group, of any monopoly in radio broadcasting or any phase thereof or in the production, sale, or distribution of radio-receiving or broadcasting apparatus; (2) the administration by the Federal Communications Commission of those provisions of the Communications Act of 1934 as amended, which relate in any manner to radio communication; (3) the manner of exercise by licensees of the Federal Communications Commission of the privileges conferred upon them by their licenses from the Federal Communications Commission; (4) the effect upon the public interest of any contract pertaining to radio to which any such licensee or any broadcasting network is a party; and (5) and attempts made by any such licensee, broadcasting network, or any person, company, or corporation, engaged in any business relating to radio, or by any attorney, agent, or representative of any such licensee, network, person, company, or corporation to unduly influence any public official in the exer-

GL-807

ONLY
\$3.50



UP TO
75 WATTS

60-MC FM INPUT
with
1/4-WATT DRIVING POWER
NO NEUTRALIZING
QUICK BAND CHANGE

Write for . . .

- Complete Ratings of GL-807 (GET-756)
- A Tribute to the Radio Amateur (GEA-3052A)

General Electric, Section 161-13, Schenectady, N. Y.

GENERAL ELECTRIC

161-13



GREAT NEWS!!—THE NEW UTILITY TESTER

The Utility Tester is a new kind of instrument for testing all electrical appliances—WASHERS, IRONERS, REFRIGERATORS, RANGES, VACUUM-CLEANERS, TOASTERS, PERCOLATORS, HEATERS, SUN LAMPS, AIR-CONDITIONING, MOTORS, etc. The Utility Tester enables every possible measurement necessary to service any electrical appliance.

Mr. Radio Serviceman, here is a new source of revenue for you. The UTILITY TESTER will enable you to accept and economically service electrical and industrial jobs you have been compelled to pass up in the past. You already possess the fundamental electrical knowledge necessary to service electrical and industrial utilities, and now you can have the instrument which will enable you to apply this knowledge to a new and lucrative source of extra income.

SPECIFICATIONS:

3 WATTAGE RANGES: A.C. AND D.C.
0-100 Watts 0-1000 Watts 0-5000 Watts.

The UTILITY TESTER reads the actual wattage consumption of any appliance, motor, etc., while it is in operation. Thus you can actually prove to the layman the actual consumption of any appliance and compute the actual cost per hour operation, basing your calculation on the local current cost. This is a feature never before obtainable in any instrument selling for less than \$50.

6 VOLTAGE RANGES: A.C. AND D.C.
0-1 Volt 0-10 Volts 0-50 Volts 0-100 Volts 0-500 Volts 0-1000 Volts.

4 CURRENT RANGES: A.C. AND D.C.
0-1 Ampere 0-10 Amperes 0-50 Amperes 0-100 Amperes.

As far as we know no instrument selling for less than \$50.00 has ever enabled current measurements up to 100 Amperes. The UTILITY TESTER provides this service on both A.C. and D.C.

2 RESISTANCE RANGES:

0-300 Ohms 0-3000 Ohms.

The UTILITY TESTER reads all resistances commonly used in electrical appliances and in addition reads extremely low resistances. For instance, 1/2 ohms appears on the center of the low ohms scale and resistances as low as 1/50th of an ohm are easily read. This is a feature never before obtainable in an instrument selling for less than \$50.

The Utility Tester comes complete with portable cover, self-contained battery, test leads, and all necessary instructions. Shipping Weight 11 lbs.

ONLY
\$11.85

SUPERIOR INSTRUMENT CO., 136 Liberty St., Dept. N3, New York, N. Y.

cise of his duties with respect to any matter pertaining to radio" . . . Ed.]

Remember the 75-kilocycle band that RCA wanted for FM broadcasters? When the Commission overruled that and assigned the stations to 200-kilocycles, it drew the rules so that this decision could be changed. A Commission unsympathetic to FM could kill off the infant just by changing this rule and confining FM to 75-kilocycle bands.

The FCC also laid down the rule that only one station in an area could be owned by an individual or organization—and that no more than six stations in the whole country could be controlled by one organization. That would knock the spots out of the chains, if they had to go into the FM field. Of course, such a rule could be modified by a more sympathetic group of Commissioners.

There are powerful men in Washington who know their way around the halls of Congress. The National Association of Broadcasters has its friends in Washington. Then there's the "97th" Senator—Mike Flynn, of the AFL typographical union. FM, which ties in nicely with facsimile broadcasting—for which no printers are needed—has

not won his approval.

The battle will be fought obscurely and indirectly for a while. But it is deadly and it is being fought on all fronts—with no holds barred.

After all, there's an empire at stake. The war in Europe may be deadlier, but it won't be any more bitterly contested than this one. —30—

Electrons & Radioman's Future

(Continued from page 9)

—blooms a tremendously important application of electronics.

Perhaps only a few of the individuals who have some present day association with radio and its allied fields will find some connection with this new art of probing for the invisible—no one knows—but at any rate there is a new horizon visible to the eye. The shadow of the coming event is clear cut and visible to all.

Electrons and the Medical Field

Short-wave therapy is commonplace in medicine, even though the research into the action of the radio wave on the body marches on, and not too much is fully known about the subject at the present time. But medicine is not confining its use of electronics to this field alone.

For a long time medical research workers have been investigating potentials developed in different parts of the human body. They were seeking very high resistance, very sensitive voltmeters. Developments in this field have progressed admirably, with simplifications of such equipment already in use in industry. These are d-c vacuum tube voltmeters. In certain ranges they are suitable for radio and industrial applications. With more sensitive ranges, they are usable in the medical field.

The use of amplifiers of extreme sensitivity and faithful reproduction are being used every day in investigation of human ills. Some of these amplifiers are so sensitive that the walk of a fly across a human hand

sounds like an army marching across a tin roof. The problems confronting the developers of such apparatus were solved through the proper understanding of electronics. Many of the engineers whose work now is far removed from radio, got their start in the latter field, branching out as their respective interests guided them.

Cancer research goes to electronics when the doctors try to discover if cancerous growths give out, or radiate, potentials of definite frequencies. There is not any reason to suppose that the research into this scourge of mankind will not eventually find its solution in electronics.

Such a small thing as hearing, a little understood phenomenon, is being tackled with the aid of the electron, for there is a curious resemblance between the action of the human ear and an ordinary amplifier. The same is true of sight and television.

Those who are close to radio would under all normal conditions, unless the contrary is called to their attention, consider the electronic devices developed for radio applications as suitable only for the radio and allied fields. Actually, the fields where such developments may be applied are tremendous, but it is necessary to seek them out—to find where what is now available can be used and what is needed to comply with the requirements of special functions.

Electrons and Aviation

Radio has been the aircraft industry's backbone, for the radio beam and radio receivers have contributed tremendously not only to safety in flying but to the very fact that the public has accepted flying as a satisfactory mode of transportation because of the high safety record. For many years now past, the height of a plane over ground has been established by the difference in air pressure at sea level and at various altitudes above sea level, as indicated upon a meter. This always represented a hazard in that when visibility was poor there was danger of colliding with a mountain or some other obstacle, because the altimeter showed elevation above sea level and not above ground. A flyer can be 10,000 feet above sea level, yet be 3,000 feet below the peak of a mountain.

Electronics came to the rescue in the form of an ultra-high frequency modulated transmitting and receiving system operating at around 430 mc, which sends a wave towards the ground and picks up the reflection. The time elapsed between the instant of transmission and the instant of reception is automatically interpreted upon an indicator in terms of the altitude above ground, or whatever solid object reflects the wave. What is the significance of this development? Is it limited solely to aircraft? Not by a long sight! It is another one of those cases where the coming event is preceded by its shadow.

Just as a wave can be transmitted downwards from the plane, so can it be sent horizontally from the plane and the reflection used to indicate the presence of an obstacle ahead of the plane. At least such does not seem impossible in the light of the completed development of the electronic altitude indicator. And if such an indicator of objects ahead of the moving plane is practical why cannot it be used on ships during a fog and even

LEARN CODE

the way you'll by using it by SOUND

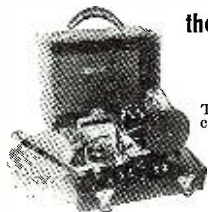

The best way to learn to read code is by listening to code. The best way to learn to send code is by hearing your own sending repeated back to you. With the new All-Electric Master Teleplex Code Teaching Machine, you learn code

the natural, easy, fascinating way. Only instrument ever produced which records your sending in visible dots and dashes—then SENDS BACK your own key work at any speed you desire. That's why practically every school teaching code uses TELEPLEX. We furnish complete course, lend you All-Electric Master Teleplex, give you personal instruction with a MONEY-BACK GUARANTEE—All at a surprisingly low cost per month. Write today for FREE catalog RN-3. No obligation.

TELEPLEX CO.—67-69 PARK PLACE—NEW YORK
In Canada, Write
Canadian Electronic Inst., Toronto, Ont.

Flexibility WITH THORDARSON

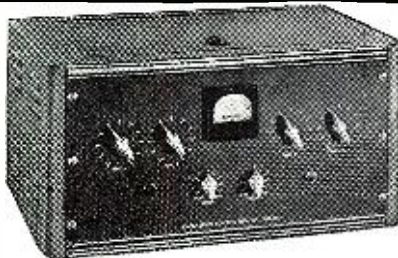

BOOSTER AMPLIFIERS

Thordarson Booster Amplifiers meet almost any power requirement. From one to eighteen units may be used to deliver power outputs ranging from 25 to 900 watts.

T-30W25—Booster Amplifier, 25 watts . . . \$85 list (with selected tubes, less cabinet. For relay rack mounting).

T-30W50—Booster Amplifier, 50 watts . . . \$110 list (with selected tubes, less cabinet. For relay rack mounting).

PRE-AMPLIFIER

This basic unit for low or high power installations has five input channels, three for microphone and two for phono input. Features Thordarson Dual Tone Control—boosts or attenuates treble or bass as desired.

T-30W04—Pre-amplifier . . . \$125 list (with selected tubes, less cabinet. For relay rack mounting).

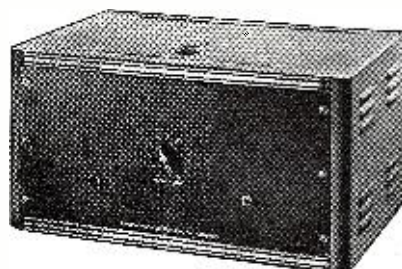

THORDARSON

ELECTRIC MFG. CO.

500 WEST HURON, CHICAGO, ILL., U. S. A.
Cable Address "THORDELCO" Chicago
TRANSFORMER SPECIALISTS SINCE 1895

in automobiles. What seems impossible or impractical today is an accomplished fact tomorrow.

Soon we may see that planes will have their positions traced on a map superimposed over a Cathode-Ray tube by a "moving spot" actuated by automatic transmitters on the ground. To become lost in the air will be impossible. On the ground, cathode-ray tubes and projection much the same as is used in large screen television will trace the movement of the plane across a map pinned to the wall, and at any moment the ground station will know where the plane is. Nor is that all. Warnings, similar to those in use by trains, will signal the pilot when another plane is approaching in the fog. Electronic apparatus will set his plane down softly, in a clearing, automatically, should the engines stop, or should the pilot be seized with illness, much the same as the "Dead-man throttle" stops a train when the engineer takes his hand off the throttle. We may even see the day, and probably will, when planes will have no engines at all, but be propelled by electrons generated on the ground, and transmitted over the ether to the plane. The transmission of radio power, in minute quantities goes on every day with every broadcast; it is only a matter of time until that power transfer is increased a millionfold.

Electrons and the Automobile

There are many electronic devices in the offing and most certainly the automobile is abundantly used to say the least. Will we always have horns? No! Someday there will be communi-

cation between cars by means of microwaves generated by electronic equipment. One car will signal the next and the streets of cities will be free of the raucous blasts of auto horns. Experiments now are being carried on with micro wave transmissions for traffic control, with speaking traffic signals which transmit signals to be picked up by the cars which approach and pass these traffic signs.

Already the automotive industry is much beholden to the electronic art. Stresses and strains of chassis are studied by cathode-ray tubes; vibration is amplified by electronic means, surfaces are tested and rejected based on the curve traced across a fluorescent screen. Paints are dried from the inside out by means of electrons, and colors matched by means of the photo-electric cell.

Electrons and the Photo-electric Cell

The photo electric cell has, in the past, found its closest association with sound motion pictures. For a number of years development has been going on upon a tube known as the electron multiplier, where in a single tube operated by a faint light or even a single electron impinging upon the surface, secures tremendous amplification. The basis of the device is secondary emission of electrons from a surface upon which the primary electrons are permitted to fall. One primary electron may be responsible for the liberation of ten secondary electrons and in two stages, this single electron may cause the emission of 100 electrons and so on, until amplification of 500,000 and more

[Please turn the page]

USE BUD COILS

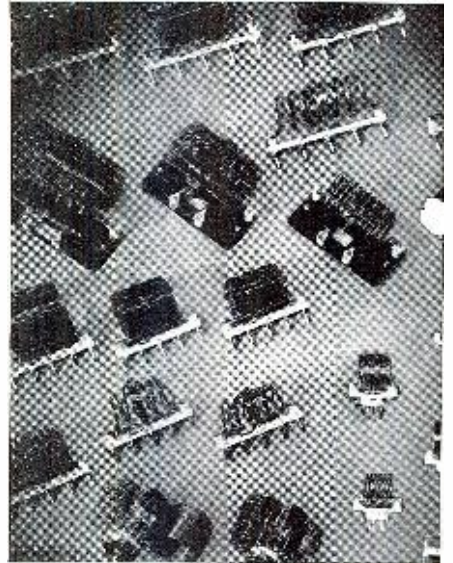

... for "peak performance"

BUD "Air-Wound" Coils assure peak performance of your transmitter circuits. They are made in many sizes and types for all applications. Your BUD jobber will be able to supply your requirements.



BUD RADIO, INC. CLEVELAND, OHIO

SEND FOR THESE FREE CATALOGS AND SAVE TRANSPORTATION COSTS ON ALL YOUR RADIO EQUIPMENT

Check This Map—and See How You Save You Pay Shipping Charges Only From Your Nearest Sears Mail Order House



Free!

Send for these FREE books Today! If you want the Public Address Equipment book, write for F732RN-3 ... or the Radio Equipment and Supplies book, write for F717RN-3

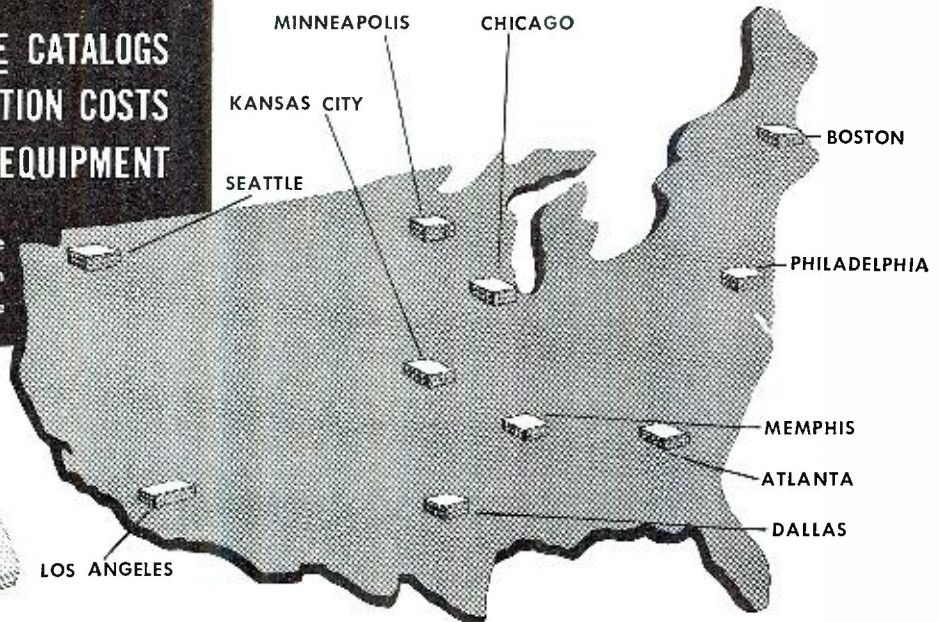

Chances are you're a Service Man or "Ham" who's "sweet" on good Radio Equipment but don't much care for high prices.

If you are, then you're in for a treat when you get your new Public Address or Radio Equipment book from Sears.

You'll see the most complete and up-to-date assortment that anyone could ask for —top-quality Equipment at those low prices

Sears are famous for. What's more, you can buy it all on Sears Easy Payment Plan!

And don't forget—when you buy from Sears, you pay shipping charges only from your nearest Sears Mail Order House! You'll save Time—you'll save Money—and you'll be Satisfied! Sears-Roebuck's famous Money-Back Guarantee absolutely protects you.

SEARS, ROEBUCK AND CO.

Chicago, Philadelphia, Boston, Kansas City, Minneapolis, Atlanta, Memphis, Dallas, Seattle, Los Angeles

RADIO OPERATORS WANTED

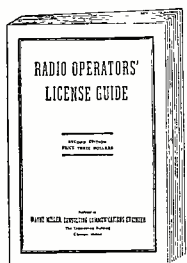

The National Defense Program is creating innumerable openings for Commercial Radio Operators—Now is the time to capitalize on your radio training and experience by obtaining a commercial operator's license and taking advantage of the many opportunities presented—The "RADIO OPERATORS' LICENSE GUIDE" has been especially prepared as a study and reference manual for those radiomen having considerable training and experience who are unfamiliar with the exact requirements for a commercial radio operator's license—Containing over 1,250 questions and answers to the new type examinations it will aid you to pass the tests—Only three dollars postpaid or purchase from your local parts distributor.

WAYNE MILLER

The Engineering Building • Chicago, Ill.

RADIO DIAGRAMS

MOST - OFTEN - NEEDED



ALL MAKES 1926-1938

In this one low-priced manual you have all the circuits you really need. 427 diagrams of most-often serviced radios is the help you want for easier, faster, and better repairs. You will find 4 out of 5 diagrams needed in this manual. 244 pages, large 8½x11 in. size. Special price... **\$1.95**

HOW TO SAVE TIME

Service hints, diagrams, alignment data, test charts, and parts lists included will prove time-savers and money-makers for you. Get these handy "on-the-job" handbooks. No need to work blind-folded. The time saved in two days will more than pay for these manuals.

**4 OUT OF 5
CIRCUITS
YOU
NEED**



1939-1940 DIAGRAMS

This single manual will give you over 80% of all 1939-40 circuits ever needed, acquaint you with recent radio developments, and teach you how to service quickly millions of sets sold last year. Models of 43 manufacturers. 212 large pages, 8½x11 inches. **\$1.50** Limited quantity at...

FREE EXAMINATION

SUPREME PUBLICATIONS, Room 644

3727 W. 13th St., Chicago, Illinois

Ship the manuals checked. I must be satisfied or you will refund my money in full.

Most Often-Needed Diagrams, 1926-1938 @ \$1.95

Most Popular 1940 Radio Diagrams @ \$1.50

I am enclosing \$..... send postpaid.

Send C.O.D. I will pay the mailman.

NAME (Write address below and send this corner).....

becomes available in a single tube.

The applications of such devices are as yet limited, but that does not mean that it always will be so. They have been used as oscillators—as light controlled amplifiers with a sensitivity tremendously greater than that of the average photo electric cell. Who can say where the limit is for light controlled devices? Instead of speaking about possible limits of application we must concern ourselves with the fact that such tubes are past the theoretical development stage and are close to commercial realities—with what the applications can be and what they will mean to those who will continue their association with electronics. Radio is just one application of electronics.

Electrons and Television

Some time ago, an amateur television system was announced, to be used by the amateur for experimental purposes. What is wrong with the application of such devices to the observation of phenomena within enclosed chambers by those who are removed from the locale? Not necessarily by radio, but by direct connection. Or visual supervision of a number of different conditions in different places of a shop or plant by one centrally located individual? Once more that which is considered as essentially an experimental radio item, is also an item of possible interest to industry for more applications than we can think of at this writing.

Electrons and the Home

Let's get closer to home. There is no limit to what electronic devices may find application in the home. Today, the most commonplace electronic device is the radio. But already it is being supplemented by the electronic piano attachment, the unit consisting of a number of fixed oscillators tuned to different frequencies and operated by means of a piano keyboard. Such devices are becoming more and more popular. Essentially, they are radio devices. That is, we seem to interpret all oscillators as radio devices, yet their application is for anything but radio. They reproduce various different musical instruments by properly combining the different frequencies which make up the basic tones of the different musical instruments. In other words, oscillating tubes are taking the place of vibrating strings and vibrating reeds. Remember the *Theremin*? It was the forerunner. No one knows where it will end but we know that this matter of electronics is going to invade the home.

Speaking about oscillators, what prevents cooking with a high frequency induction furnace? Induction furnaces are used in many forms of industry. Why not the home? Eventually it will appear in madam's kitchen. It just needs the first concern to start it. And why only the kitchen? How about some sort of a recording device which will make a record of messages intended for the man or the woman in the household, when she is not home to answer the phone? Some sort of an electronic device will by means of a pulse sent over the telephone wires when the phone bell rings signal to the person calling that no one is there to answer the phone but that all is ready for a one minute message. Madam comes

home and operates the recording device, learns who has called and why. Can anyone say that a necessity of this type will not appear until generations are past? Not with the tremendous strides being made in electronic development.

Why not intercommunicating systems in the home? Maybe not all homes but in many homes of more than two or three rooms. The day will come, and that is another application of electronics. Capacity operated burglar alarms now are being used in many homes. That is an electronic device. Why not radio communication between husband in his car on the way home from work and wife waiting at home? That is not impossible on an ultra high frequency band. Maybe that is far distant, maybe not. It all depends how fast electronic science learns the working of waves of extremely high frequency. Such transmission now is being carried on by means of radio and telephone through a central to ships at sea and tugboats plying the harbors and rivers of the large cities.

Is there any reason why people in a home should grope in the dark when they enter a room at night? A photo cell can turn on a main light. It is already being done in some homes. That is the application of electronics in the home and there is no doubt that it will increase.

Photo cells open garage doors, doors between rooms, count packages, protect machine operations, sort fruit and other objects, match colors, rejecting them when they are not within certain tolerance limits—in fact, do a thousand and one things. In comparison with the number of such applications in the future, the present numbers are frightening.

Electrons and the Military

We are witnessing a war, the like of which has not been seen nor reported on the face of the globe. Yet electrons are playing an important part 'way beyond the mere use of communications. It is the electron that betrays the approach of the enemy, his plane or his tanks. It is the electron which is being used to set bomb sites. Electrons light the big searchlights, carry the fire-fighters to their work, sound air-raid warnings, purify the air in dugouts, move trains, and keep the war going. It has been truthfully said that if it were possible to stop the electrons, the war would cease *immediately*—but so would all life.

In the future we will see electrons put to deadlier uses than ever before. Electrons will kill at great distances, will poison the air, the food, even the water of the enemy, without a single human being being at the spot where the terrible work is being done. Whole armies will be moved without gasoline, and the war for oil may become a forgotten thing. The tactical displacement of troops will be done on maps illuminated by cathode rays indicating the presence of the enemy. Television has already been tried out as a valuable adjunct to the army reconnaissance. Un-interruptable and non-disruptable communications may be carried on by means of supersonic waves, at speeds approaching 100,000 words per second. The country that masters the electron art the furthest will eventually have the edge over the whole world.

(Continued on page 49)

(Cont. from bottom p. 48)

Electrons and Sports

Going from war to more peaceful pursuits, electronic devices will be used in sports. The electric timer is commonplace. The *electronic* timer which will make more accurate measurements possible will become even more used. Non-glare lighting effects, induced by proper application of electrons will make the night into day, and make it possible for the half of the world that works during the day to witness sports now impossible to see at night. Such a sport would be horse polo, or an automobile race in Indianapolis. Muscular fatigue from sports activity will be repelled by electronic medical appliances, and the benefits of fresh air will be given to all those whose work keeps them in the big cities.

Electrons and Industry

In industrial uses the electron is just on the threshold of coming to common use. Day by day the means of simplifying work by electrons is advancing. The tremendous impetus given by the National Defense Program will in all events multiply the electronic units employed in industry. Where man-power is at a premium, where time is of the essence, electrons move so fast, and are so tireless, that it must follow that they will take over much of the work that is now being done by humans.

Conclusion

From this remarkably short review of a small part of the electronic art can be seen that we are on the verge of the Electron Age. Just as the Gasoline Age, the Flying Age, the Electrical Age, have all left their mark on the world, so will the electron. To every radioman, to every serviceman who reads this, remember that to you is granted the opportunity of getting in at the start. There will be fortunes made—and lost—in this new field. You already have more than a smattering of the subject. Why not get in on the "kill"? Now is the time, before electronics are upon us in full blast, to become acquainted with the art, with the fundamentals of the underlying physics of electronics—with what makes the electron "tick"—with what this element, which no one has ever seen, tasted, smelled, felt, or weighed is doing the world over.

Electronic Maintenance

(Continued from page 25)

cialist in such work? There is no doubt that many cities will follow in the footsteps of New York City and a few others in their attempt at noise abatement. Such noise investigation carried out with "noise meters," as, for example, that made by *General Radio* is not a far fetched thought.

But to get back to signal sources

suitable for audio work, there are a few other details to consider in addition to the frequency range. But before doing so, it might be well to comment about a few more industrial applications as they relate to both investigation work by this modern service shop and the performance of maintenance duties upon such apparatus.

Much interest has been focused upon stroboscopic observations of moving elements. By this is meant the flashing of a beam of light of specific frequency upon some revolving or vibrat-



Performance!
tells the Story

AT
**WLME -
W4NG**

HQ-120-X

WLME-W4NG has held daily schedules with the Antarctic Expedition at Little America for over a year, and during that time, over 12,000 messages have been handled. Mr. Edward J. Day (ED), Chief Operator of the station reports that the "HQ-120-X" has been giving excellent results. He says, "The chief piece of equipment in the station is the 'HQ-120-X'. This receiver was responsible for continued success in receiving the many messages from Little America." Some operating periods were as long as four hours and at speeds of 40 to 45 words per minute, and to use Ed's words, "A receiver of lesser quality would have been too great a strain on the operators."

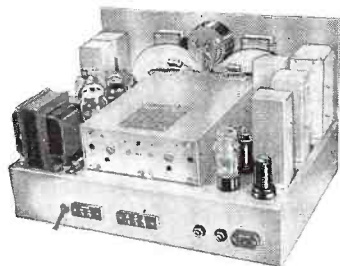

The "HQ-120-X" is the last word in receiver engineering and we think it is the greatest dollar value ever offered to the amateur. Just operate an "HQ-120-X" and you will immediately see the difference, or ask the ham who owns one and he'll tell you it's tops in every respect. Altho the average ham doesn't operate 40 to 45 words per minute hours on end, he will appreciate the smooth, stable performance of the "HQ-120-X".

WRITE DEPT. RN-3 FOR "HQ" BOOKLET

HAMMARLUND MFG. CO., INC.
424-438 WEST 33rd ST., NEW YORK

EXPORT OFFICE: 100 VARICK STREET, NEW YORK CITY

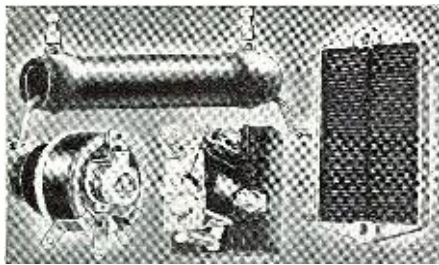

RELAYS RESISTORS RHEOSTATS

The oldest and most complete line on the market for service and amateur use. Proven dependability and conservative ratings. You are not experimenting when you install Ward Leonard items . . . you know they are right.

WARD LEONARD RADIO SPECIALTIES

WARD LEONARD ELECTRIC COMPANY
47 South St., Mount Vernon, N. Y.

Please send me Circular 507 covering Relays, Resistors and Rheostats.

Name

Street

City and State

Call Signal

SAVE MONEY

WITH THIS

Free Book

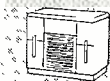

RADIOS



PARTS



P.A. EQPT.



HAM EQPT.

What a book to have! Just open it to the section you are interested in—there's your radio, sound system, your choice of nationally advertised parts. Everything in radio is here. But that's only the start of the story! Lafayette prices are the lowest—saving you money on everything you buy. Send for your FREE copy of this great buying guide today. Just tear out and mail the coupon.

Lafayette Radio

100 SIXTH AVENUE, NEW YORK, N. Y.
CHICAGO • ATLANTA • BOSTON
NEWARK • BRONX, N. Y. • JAMAICA, L. I.

LA FAYETTE RADIO CORP.

DEPT. 2C1,—100 SIXTH AVE., NEW YORK, N. Y.

Rush FREE Catalog No. 82

NAME

ADDRESS

CITY.....STATE.....

ing member and so creating the optical illusion of "stopping" the part that revolves or vibrates, or "slowing down" the speed of rotation or vibration of the part. In this way critical observation of the moving part is possible while it is in motion. By flashing a strong light which varies in intensity at a rate equal to the speed of rotation or vibration per second of a device, it is possible to "stop" the device as far as the eye of the observer is concerned. By having the frequency of the light and the device differ by a small amount, say a cycle, the device being observed can be seen as making its complete revolution or completing a cycle of vibration in a second.

Equipment of this character requires a variable source of audio frequency and sufficient amplification so as to secure the proper amount of power to operate the "glow" lamp, which in many cases is a high powered neon lamp. As to the range of frequencies employed for such operations in industry, they vary in accordance with the type of mechanism involved. For machinery, a frequency up to 200 cycles per second will accommodate apparatus rated as high as 12000 r.p.m. For higher frequencies, the light source would operate at higher frequencies.

It is of course understood that the nature of such stroboscopic apparatus depends upon the nature of the equipment to be observed. But much can be done with a simple audio oscillator, a two to five watt audio amplifier and the light source. And the nature of the observation is not necessarily limited to viewing rotating devices. Anything that is recurrent with respect to position and time can be viewed by means of such light, as, for example, a continuous sheet of printed material, upon which the imprint reappears time and again, as, for example, in a multi-color press operating at high speed which can be adjusted for register as the press is revolving.

The possible application of such apparatus and those of the vibration variety are too numerous to enumerate at this time, but what has been said should furnish an idea of the possibilities of the future, for him who has confidence in the future.

As to the signal sources for audio maintenance work, what are the requirements? It depends upon the nature of the work, so perhaps it would be a good idea to consider a few of the needs. We have spoken about the frequency range. A range of from 30 to 15000 cycles will take care of a great deal, although it is true, judging by developments, that the technique of the future is progressing towards the use of square waves for the investigation of the characteristics of many different types of audio amplifiers. This, however, does not preclude the use of the *sine* wave audio oscillator as the basic signal source. Developments brought forth by work in television have produced very simple and inexpensive "clipping" units which can be applied to any *sine* wave audio signal source so as to furnish a square wave which has a fundamental determined by the frequency setting of the *sine* wave oscillator. [Any one who is interested in the schematic of such a simple clipper system, can secure the required data by communicating with the author at the address shown at the beginning of this article.—Ed.]

Since distortion is a factor in audio amplifier operation irrespective of the nature of the amplifier, one of the requirements of the conventional audio signal source is minimum distortion in the available signal. In other words, if for conventional testing of an audio amplifying system, a *sine* wave is suitable, then the signal source must be productive of the closest possible approach to a *sine* wave, within, of course, reason. We say this because the matter of obtaining the closest approach to a *sine* wave consistent with meeting the other requirements of such signal sources reflects greatly upon the cost of the device. The greater the freedom from harmonics in the audio signal source output, the higher the cost. Thus the choice becomes one of finances versus the technical requirements.

Audio signal sources are available from several companies such as RCA, General Radio, Ferris, Hickock, C-B, etc., which companies furnish units of the better quality and comparatively high cost. In these units overall harmonic distortion approximates several tenths of one percent. In the lower price brackets are units from RCA, Triplett, Supreme, Jackson, Superior and several other companies. It is this latter group which are most commonplace in the maintenance field and it is from this group that we select the audio signal source for our communication and maintenance shop. Devices coming within this category are found capable of supplying the needs of our modern service station for all of the applications mentioned. With overall harmonic content reduced to about 1 percent the approach to a *sine* output is sufficiently close to permit easy observation of any distortion introduced by the equipment under test. With the clipper unit added to such a signal source, a very satisfactory square wave is produced for those occasions when the development of transients within the amplifier must be investigated.

Another requirement of such signal sources is a substantial output. As a rule a power output of about 60 to 70 milliwatts across loads of from 250, 500 and 5000 ohms is ample for everyday work. Such a power rating will furnish voltages approximating between 4 and 5 volts across 250 ohms, 6 to 7 volts across 500 ohms and about 18 to 19 volts across 5000 ohms. These impedance values embrace the figures usually found in audio frequency systems of all varieties, although it is true that in many of the modern systems, the input impedance of the first tube is usually very high. This is particularly true in the case of audio systems used in receivers. In public address amplifiers and others of like variety, if the input signal is fed across the microphone load, the load impedance will usually be one of these mentioned.

At the present time, maintenance operations upon audio systems are of varied type, such as the measurement of the gain or amplification at various frequencies; the observation of the character of the output wave by means of the oscillograph; input-output voltage relations also developed by means of the oscillograph and the development of transients which are productive of overload. For this type of work the square wave generator is used with an oscillograph. For that

matter, such observation is suitable for determination of the general operating characteristics of the amplifier. However, we feel that some day instantaneous overall frequency response measurements will be made available by means of frequency modulated audio frequency oscillators and the oscillograph. In such cases, the pattern appearing upon the oscillograph will be an overall response curve such as we now secure in connection with alignment operations. Of course the shape of the audio response curve will differ from that of the r.f. or i.f. curve.

So much for the subject of audio signal sources for the present. As you can readily understand, what we have said herein by no means exhausts the subject. Many times more may be said in the form of extended discussion of what audio activity may be. We hope that what has been said herein will at least give you some idea of what the field is, as far as the signal source is concerned and what general requirements for such signal sources are in the various branches of communication and electronic maintenance. A few additional facts are given below in connection with the oscillograph, which is the next of the items to be added to this modern service shop bench.

The Oscillograph

Recognizing the basic function of the oscillograph, we can readily understand its association with the audio signal source, for it is the means of establishing the presence of distortion in audio systems by examination of the signal voltage or current waveform. While it is true that the process of signal tracing has nullified some of the applications of the cathode-ray oscillograph, there still remain sufficient applications in a shop of the kind we are discussing in these articles to make necessary the inclusion of a cathode-ray oscillograph. For example, the process of alignment by means of the oscillograph is applicable to all of the receiving systems described in this series for none of the branches of activity employs such receiving systems as are beyond the application of the oscillograph for this work.

The same is true of the application of the cathode-ray oscillograph for the observation of audio voltage waveform. For the measurement of audio frequency voltages, or for relative indications of audio frequency voltage amplitudes when waveform is of no concern, there is no need for the oscillograph, in that practically all signal tracing units contain audio frequency channels which have a much higher input impedance than the oscillograph, hence do not load the audio circuits, particularly if they are high impedance circuits,—as is the case in very many audio amplifiers today—as much as the oscillograph. These channels in signal tracing equipment are calibrated or can be calibrated so as to be equal to amplitude measurements upon the oscillograph.

But this does not nullify the value of the oscillograph of modern design. For example, the vibration tests mentioned earlier are made with the oscillograph as the indicator of both amplitude and frequency. The visual tests made upon audio amplifiers us-

Home Recorder FREE!



MAKE RECORDS AT HOME

SELF-STARTING ELECTRIC-PHONO



FACTORY-TO-YOU SAVES UP TO 50%

15-TUBE

MIDWEST

RADIO-PHONO COMBINATION

30 DAYS TRIAL

EASY TERMS

with FREQUENCY MODULATION and TELEVISION ADAPTATION

15-TUBE TILT-FRONT



CABINET MODEL RADIO-PHONO COMBINATION

\$29⁹⁵

COMPLETE

THRILLING WORLD-WIDE FOREIGN NEWS DIRECT!

UP TO \$25 TRADE-IN ON YOUR OLD RADIO OR CHASSIS
(On Many Models up to 18 Tubes)

YOU'LL enjoy listening to fine recordings on this new type electric phonograph, and you'll be delighted with this amazing, ocean-spanning radio. Make your own records on the Home Recorder (sent FREE for a limited time) with this Radio-Phono Combination. Big FREE catalog pictures many beautiful 1941 factory-to-you radio chassis and console values—from 6 to 18 tubes — up to 5 bands — including automatic record-changing radio-phonograph, home recorder, etc. Get our **LIBERAL TRADE-IN PLAN**, and 30-day home trial offer. Write for **FREE** catalog today

ONLY \$22⁵⁰

COMPLETE RADIO-PHONO CHASSIS with TUBES and SPEAKER

MIDWEST RADIO CORPORATION
DEPT. 11-GG CINCINNATI, OHIO

USER AGENTS WANTED

HOME RECORDER FREE

Airline SOUND SYSTEMS

Greatest Value Ever Offered

... Say Sound System Men

If you want the most for your money in a sound system, note these few expressions, typical of hundreds, about the Ward Airline from men out on the firing line: "Far better than others!" "Exceeds expectations!" "Best I ever heard, and I have owned several!" "Compares with others twice its price!" "Easily the best for the money!" "Surpasses other equipment that costs much more!" **WHY?** They say it's because of Airline's marvelous tone quality, its volume without distortion, its adaptability to any use, indoors or outdoors, its low upkeep!

GET NEW CATALOG FOR MORE OF THE FACTS

The Airline Sound System Catalog is packed with additional facts you'll be interested in knowing. Shows sound systems for every purpose, and how to select the proper amplifiers, speakers and mikes for your own needs. Offers you tremendous savings because of Wards direct selling plan . . . savings PLUS performance. Send for this **FREE** Catalog NOW! Mail the coupon!
Profit by Wards Time Payments 15-Day Trial Money-Back Guarantee



Montgomery Ward

9 GREAT MAIL ORDER HOUSES
MORE THAN 600 RETAIL STORES

MONTGOMERY WARD & CO.
Dept. RN-43, Chicago, Ill.

Please send me your **FREE** Sound Systems Catalog at once!

Name _____
Address _____
City _____ State _____

RUSH COUPON

New EFFICIENCY

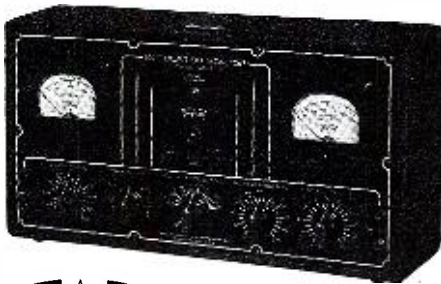

TRIPLET MODEL 1696-A

You've solved your problem of getting maximum efficiency from your transmitter when you invest in a Model 1696-A Modulation Monitor . . . A new monitor with improved shielding—just the unit for 10-meter bands. Plus it into your AC line—make simple coupling to the transmitter output and the monitor shows:

- Carrier Reference Level • Per Cent of Modulation • Instantaneous Neon Flasher (no inertia) indicates when per cent of modulation has exceeded your predetermined setting. Setting can be from 40 to 120 per cent.
- Helps comply with FCC regulations. Has two RED • DOT Lifetime Guaranteed Triplet Instruments. Modernistic metal case, 14½" x 7½" x 4½" with black suede electro enamel finish. . . . Black and white panel.

Model 1696-A . . . Amateur Net Price . . . **\$34.84**

Also available as a rack panel mounting unit.
FOR MORE INFORMATION
WRITE SECTION 153 HARMON AVENUE

THE TRIPLET ELECTRICAL INSTRUMENT CO.
Bluffton, Ohio

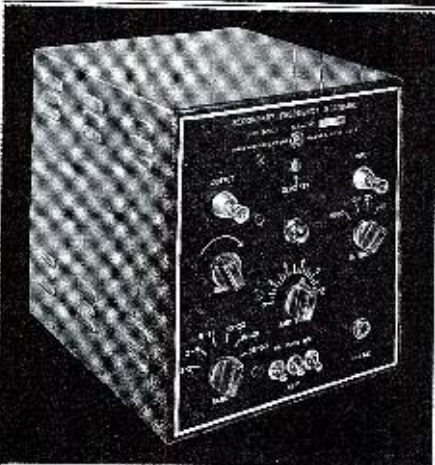

A NEW Precision Crystal Secondary Frequency Standard THAT HAS BEEN

"Designed for Application"

A precision frequency standard capable of being adjusted to WWV or some other primary standard and putting out uniformly accurate calibrating signals with 10, 100, 1000 KC intervals. Uses the new GENERAL ELECTRIC No. 18A 1000 KC crystal having a frequency temperature coefficient of less than one cycle / Mc/C°. The crystal is sealed in Helium in a standard metal tube envelope.

The self-contained AC power supply has VR150-3F voltage regulator tube.

In addition to oscillator, multivibrators, and harmonic amplifier, a built-in mixer with phone jack and gain control on panel is incorporated.

Catalogue Upon Request

JAMES MILLEN  **MFG. CO. INC.**
150 EXCHANGE ST. MALDEN, MASS.

ing the square wave signal source require the oscillograph. Measurement of the percentage of modulation of various types of modulated oscillating systems, either local or of received signals is another application which may find abundant use in the future. In general, the cathode ray oscillograph may not find application in every single maintenance operation, but it will find sufficient application in connection with audio frequency operation to fully justify its inclusion.

As to the requirements of cathode-ray oscillographs, with respect to reaching a decision as to selection, that is a matter with many angles. There are in the field today many oscillographs, the majority of the three-inch variety. These can be used, but as can be readily understood, progress has been made in the design of oscillographs just as in other apparatus. The approach of television and its servicing requirements has forced changes in those test units which are made ready for such operation. For example, there has been a tendency towards five-inch screen tubes rather than three-inch screen tubes because of the greater convenience in interpretation of the larger pattern. Due to the fact that circuits under observation are of higher impedance, the input impedance of the vertical amplifier has been increased to about 1.0 megohm from around 500,000 ohms.

Because of the higher frequencies which are subject to observation with such five-inch tubes, the frequency response range of the vertical amplifiers has been very greatly expanded in both directions. Whereas in the older three-inch instruments it was commonplace to provide a frequency response in the vertical amplifier of from about 20 cycles to 90,000 cycles, the modern five-inch tube units have a frequency response of from 5 cycles to about 500,000 cycles. In the case of the horizontal amplifiers, the frequency response range has been extended downward to about 5 cycles instead of the lower limit of 20 cycles in the three-inch instruments.

The fact that comparatively low frequencies will have to be observed in the future a change has been effected in the timing axis or sweep oscillator of the new oscillographs. Whereas the "low" in the older units was about 20 cycles, the new units of modern design go down to 4 cycles. Whereas the older units had a "high" of about 15,000 cycles, the modern units have an extended range up to about 22,000 cycles.

Because of the higher sensitivity to be needed for all around application, advances have been made in the sensitivity of these five-inch jobs. The usual deflection sensitivity of the old three-inch cathode ray tube units at the amplifier terminals was about 2 volts. Today, in the five-inch units this has been increased to about .04 volt. r.m.s. per inch when the input cable is not used and to about 0.4 volts r.m.s. per inch when the cable is used.

It is because of such advances in the general design of cathode-ray oscillographs that we incorporate one of the new units instead of suggesting that one of the older types be incorporated in the bench. However, there is nothing to prevent anyone from using the oscillograph they now have in their possession. The important thing is to have one on the bench.

So we conclude the basic test units required for such a modern test bench. With these units we are ready to tackle most anything that comes into the shop today and for a long time to come. Naturally, there may arise occasion for special apparatus, some of which we shall consider in the forthcoming installments when we shall apply those units which we have selected for this typical communication and electronic test bench.

Perhaps you are surprised to note the absence of a tube tester. We realize that one is needed, but it does not belong upon the test bench panel. Therefore it will be discussed as one of those supplementary units which belongs in the service shop. —50—

Amateurs Rescue Amarillo

(Continued from page 6)

ing the streets. There was further danger from more wires, crashing poles and trees. Later, in darkness, the city groped its way about, taking inventory of damage.

News of the disaster had leaked out to the outside world, but only fragments of the condition could be picked up from stray travelers who fought their way through the storm. At fitful intervals, while power was still available, word of Amarillo's plight went sputtering and crackling out miles over the frigid air by short wave radios, operated by more than a dozen amateurs. Power continued to fail until "hams" were forced to use portable power units.

Necessity became the mother of invention, and as a result, ready-made and home-made power sets swung into action. Throughout the first night, and for several days until other communications were established, amateur operators stuck to their controls and sent message after message out of the stricken area. A modern city of over 50,000 had fallen back on a mode of communication that has been proven ever reliable in an emergency—the radio amateurs.

Emergency traffic was given priority in four stations which were extremely active during the emergency. To district headquarters of telephone and telegraph companies went urgent pleas for repair crews and materials. To public service companies went information of the damage and the plight in which the city found itself. To water supply stations in several states went calls for tanks and railroad cars of drinking water. Typhoid, ever a threat in an emergency, had to be avoided.

Trains, completely "lost" as far as dispatchers along the lines were concerned, were located and set in motion again, operating on orders transmitted over short wave. These orders sometimes found themselves thousands of miles from their destination in the process of being relayed through.

First contact with the outside world after all power failed except in isolated sections, came Sunday morning when John W. Terry, operating W5HYT got through on 10 meters to Boyd W3CBT Cowan, in Parkersburg, Pa., and handled telegraphic traffic until his power failed an hour or so later. Following his failure, Fred W5IRU Trotter, took up the contact with W3CBT until his power also went out.

The job was passed on, for a valu-

able contact should not be lost, and Bert W5WX Arnold took up the job. Armfuls of messages waited transmission. The same fate awaited the third station and a few minutes later his power went out.

By this time, Wally W5HLG Wall, was on the air, moving messages for public service companies as fast as his equipment could handle the traffic, until, as per every one else, his power went out. Then W5WX moved into offices in the *Amarillo Electric Company* with a portable unit, and he and Irvine W5CHG Doss, went on again Sunday evening on 160 meters.

By Sunday evening, power failures were being corrected. J. P. W5FTI Williamson, had moved his 160 meter transmitter to the telephone offices and was handling messages from that point. Williamson and Wally Wall, assisting, strung an antenna from the top of the city's tallest building, the 14 story *Santa Fe Building*, and moved plenty of traffic from that time on.

Meanwhile, Tex W5CYX Smith and others had got under way again. Smith strung a haywire antenna from the top of the two-story *Globe-News* newspaper office and put the transmitter on the second floor on 160 meters. Power failed in this station and a newspaper truck moved a portable 800-watt, 100 Volt AC *Kohler* power plant to the pressroom before Smith could continue. A nerve center of broadcasts from the stricken city, Smith's station was the object of much concern over the "ham" world before he came back on.

Smith is a linotype operator for the newspaper and was extremely active in transmission of messages to the outside world. He spent 60 hours all told at his radio, 12 hours at one stretch and sent out 181 straight messages, all limited to emergency and semi-emergency contents. A ham for 25 years, he gave all credit for his success to cooperation from outside amateurs and tossed verbal orchids to W5JFF, Fort Worth, Texas, for "holding" his frequency.

"I can truthfully say," W5CYX told listeners after it was all over, "that had it not been for amateur radio, not mine particularly but the field in general, Amarillo would have been a much longer time getting the necessary men and materials here to repair the damage. This delay would have meant suffering from lack of water and other inconveniences."

Throughout the emergency period, hundreds of carloads of supplies including 12,000 poles, miles of wire, crossarms, insulators, ties and others were ordered from Fort Worth, Denver, Dallas and many other points. Hundreds of men were dispatched to the scene. Thousands of words in press messages went to every major news agency in the nation. Traffic was handled for telephone, light, and water companies, city officials, police officers, and business firms and individuals. And all via ham radio.

During the height of the storm, Amarillo was truly a city reverted to the "good old days." No water, no lights but a few obsolete kerosene lamps and all the candles Amarillo stores were able to buy. Water was hoarded in tubs, buckets and fishing pails. Flashlights and torches gleamed on every hand. Life went on, cramped, no doubt, but in a spirit of good humor

AS CHIEF CONDENSER BLOWER OUTER OTTO OOMPH WAS A FLOPPEROO

Ever since Otto Oomph was a boy, he suffered from a strange disease. Smashophobia, the doctor called it—the horror of breaking things—but there was nothing to be done about it. When he broke a Christmas tree ornament one year, poor Otto cried for two days. When he grew up, he wouldn't shoot as much as a clay pigeon and even the thought of denting the fender of his car would make him sick.

Eventually, however, Otto became an electrical expert. That got him a job in the Sprague Laboratories and Otto was really happy for the first time—that is, until someone made him Chief Condenser Blower Outer in the Test Division.

Now, voltage in the electric chair at Sing Sing is 1,200 volts. In contrast, controllable AC voltages in the Sprague lab run as high as 7,200 (and much higher in the special high voltage lab) for here is where Sprague condensers really get "the works." They are torn apart, blown apart, tortured and blasted, not only to see how good they are, but how to make 'em even better.

WHAM! Poor Otto jumped six feet when a can condenser, deliberately loaded with supercharge to determine its breakdown point, exploded in a cage.

Bam! SNAPPETY-CRACK. Otto shivered as another condenser gave its life under 4,000 volts of D. C. . . .

CLICKETY-CLICK in monotonous regularity as AC refrigerator motor starting condensers were switched tortuously on and off 150 times an hour.

SIZZ-SIZZLE and SISS as vapor streams played on condensers to prove their moisture-proof ability.

In a massive oven, dozens of units were undergoing life tests at 200°



F. Elsewhere, Television condensers were telling their story under 3,000 to 10,000 volts of DC; tiny electric razor condensers were getting the equivalent of 14 years of the hardest kind of use; and almost every minute some condenser gave up the ghost and another fact was added to the science of constructing condensers that excel in the rough and tumble usage of the field.

"I can't stand it—I can't stand it," wailed Otto at last, weeping over the remains of an 8 mfd. 450 V. Atom midget dry electrolytic.

"Gosh, Otto," consoled an engineer. "What you worrying about? That condenser is only rated at 450 V. We had to smack it with a surge of almost 700 V. before it went."

"Sure," sobbed Otto. "But I can't stand this business of busting things. It ain't fair to treat such swell condensers so downright mean. It makes me sick—I wanna quit."

And quit Otto did. 'Twas a year before we heard from him again and then he wrote:

"Dear Boss: Maybe you think I was silly to quit my job, but it just isn't my nature to bust things up. I'd go home nights and dream about condensers on those torture racks—the finest condensers in the world just waiting to be blown up even if it took all the power in Massachusetts to do it.

"But all's well that ends well. I'm in the radio service business and doing fine. I use Sprague Condensers—and boy, are they real! Not a blow-out in a carload. No failures from moisture—or anything else in fact. I realize it's largely because of the work you guys are doing back there in the lab, but I still say blowing up condensers is a helluva job for a sensitive man like me. Love and Kisses.

OTTO OOMPH"

SPRAGUE PRODUCTS COMPANY

North Adams, Mass.

(Advertisement)

COMPLETE

RADIO COURSE

\$1.95

POSTPAID

HOW 9,348 RADIOMEN OBTAINED THEIR TRAINING



HELPS YOU GET A RADIO JOB

"The radio training course is the finest, up to date, easy to understand course. . . This course outlines practical work. We are using this course in our Topeka High School. It is wonderful." Henry Ward, Jr., Topeka, Kansas.



"You should get more money for the R.T.I. Course. The first week I studied it, I made \$10.00 repairing sets. I built my own test outfit from details given in this course. I have repaired 100 radios to date. . . ." Robert C. Hammel, Davenport, Iowa.



"I am very satisfied with the course. When I was at the twelfth lesson I started to repair radios. It took me two months to master your course." Roger Lanzlois, Montreal, Canada.



"I have found since taking your course how modern and up to date it really is. There is not one page in the whole course which anyone interested in radio can afford to miss. Your course started me on the road to a well paid job and has repaid me many times." Charles A Spach, Reading, Pa.

You may also get exact reprint of the regular \$39.00 Radio Technical Institute course for only \$1.95, the full price. The course is complete in every way and exactly the same as higher priced original lessons.

AMAZING REDUCED PRICE

Learn to repair all radio sets expertly. From the very start you are introduced to practical equipment and methods. A single time-saving hint will more than pay for the special \$1.95 price for the complete course and all supplementary material. Tells you how to become a first class radio serviceman with easy to follow lessons.

PREPARED FOR HOME-STUDY

Get ahead in Radio with this complete training. No special education or previous experience required. The streamlined lessons are clear, interesting, easy to understand and use. A final examination and diploma available after course is finished. Special \$1.95 price for the entire radio course can be earned the first hour of radio work.

NEW LESSONS

Every phase of radio including television, P.A. troubleshooting, short-cuts in servicing, essential theory, practical construction, and all other important branches.

EVERYTHING ABOUT RADIO

Reprinted in 1940, with added facts on signal tracing, P. A., television, photocells, and every other important development. Forty-three radio manufacturers helped to prepare this course. This training will give you data you need on the job. Limited quantity of courses printed. Look the lessons over in your home without any risk.

10 DAYS' FREE EXAMINATION

SUPREME PUBLICATIONS, Room 634, 3727 W. 13th St., Chicago, Ill.

Ship the complete course on approval without any obligation to buy. I may keep the course for 10 days. If, for any reason, I am not pleased, you guarantee to refund my money.

I will pay \$1.95 and 15c postage to the mailman.

I am sending \$1.95, the full price, ship postpaid.

Name: _____

Address: _____

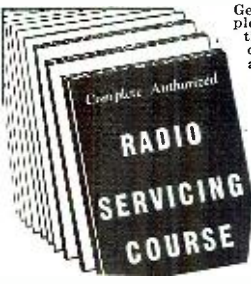

A FAIR QUESTION—

"What will CREI training do for Me"

CREI training will do nothing for you, if you are content to wait for someone to hand you a better radio job on a silver platter.

But if you are ambitious and desire to improve your position then CREI advanced technical training backed by your own radio experience should help and equip you for a higher-salaried technical position. A survey of our graduates discloses that as a group they are among the highest paid in radio—69% enjoy salary increases during or immediately after their training! 5,000 other radiomen can't be wrong. Why don't you follow them to a better job by enrolling now?

WRITE FOR FACTS TODAY—

Let us send you our interesting booklet, together with personal recommendations for your success in radio. To help us intelligently answer your inquiry, please state briefly your education, radio experience and present position, also whether interested in home study or residence training.



Free Booklet Sent

CAPITOL RADIO ENGINEERING INSTITUTE

Dept. RN-3, 3224-16TH ST. N. W., WASH., D. C.

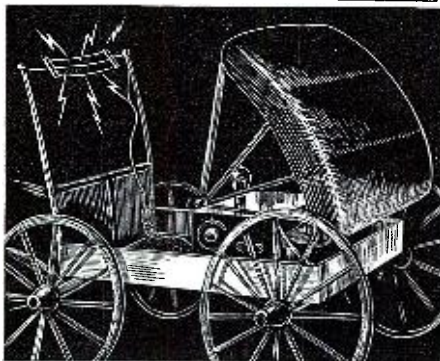

No . . . Your Outfit Isn't As Out-of-Date As This . . . But

* Far-fetched, perhaps . . . but the above picture should bring home the idea that your rig can still stand improvement. Why not make it fully automatic using Relays by Guardian. The cost? Surprisingly low . . . and your set becomes one of the best in your district.

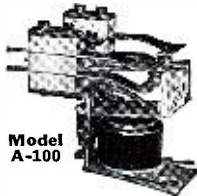

Standard A-100 and A-100-C Antenna Relays Alsimag insulated operate on 110 V. 60 cycle A.C.

Amateur List Prices:
A-100 Double Pole Double Throw Relay . . . **\$5.95**
A-100-C Single Pole Double Throw Relay . . . **\$3.30**

R-100-G Triple X insulated . . . **\$5.00**
Write for New Bulletin "N" and Free Circuit Diagrams. Order Today!



GUARDIAN ELECTRIC

1630 W. WALNUT ST. CHICAGO, ILL.

notable to the Southwest. There were no elevators and persons living on high stories of buildings either walked many flights of stairs to and from home or just stayed home in the first place. Banks could not open, time vaults were electrically operated, and there was no electricity. There were no malted milks, no electricity to run the mixers. Auto traffic was paralyzed for only a few pumps in town were not operated by electricity.

It was radio, amateur radio, that speeded up the process of returning to normal life.

And in the radio activities, one of the most commendable pieces of work was turned in by W5CYX, through the cooperation with Dick W5DER Watkins in Clovis, New Mexico, and Dewey W5IQN Thomas in El Paso, Texas. Between the three, a "lost" train, the transcontinental "Scout" running from Chicago to Los Angeles, was finally located in Pampa, Texas, after leaving Wellington, Kansas, for Texas points. Through Clovis and the El Paso ticker system, Santa Fe officials in Amarillo were able to determine the train was stopped in Pampa awaiting further orders, orders that could not be transmitted except via short wave via Clovis and El Paso and back to Pampa. When the train whistled into the Amarillo yards, it was a signal for orders to be dispatched along the line for the movement of other trains, several tied up in Clovis, one in Texico and others along the line.

Later, a telegram of approbation was received from J. B. Felsenheld, Amateur Radio Relations Director for Western Union, a telegram which indicated that Don W4FT Parsley, Wilmington, N. C., Fred W5IRU Trotter, and W5CYX would be awarded *Certificate of Public Service* in connection with outstanding service. Awarding of the certificate will come because of a message concerning a blood transfusion that went from Amarillo to Wilmington and back to Clarendon, Texas.

Another outstanding station operating out of Amarillo during the crisis was W5ECL, with Dr. Wm. B. "Tommy" Thomas at the controls.

Many of the men who cooperated in this emergency have had similar experiences before, but never so much in their "own backyards."

While we may very well be forgetting many who helped, among those Amarillo hams who cooperated during the ice crisis were Jack W5QE Morris; Bert W5WX Arnold; Jimmy W5AVM Redfeare; Kenneth W5AZQ Barton; Carl W5BGT Kilander; Russell W5BTW Leach; Irvine W5CHG Doss; Tex W5CYX Smith; Dr. Wm. B. W5ECL Thomas; Allen W5ENK Reppeart; Al W5EYX Reville; J. P. W5FTI Williamson; Neil W5GEE Clark, Jr.; Ed W5GIB Weir; Mrs. Irvine "Jean" W5HYF Doss; Dory W5GJG Franz; Maurice W5GZZ Hopson; Wally W5HLG Wall; John W. W5HYT Terry; Jim W5HZA Glenn; Howard W5IAN Blaker; Lester W5ICR Richards; Fred W5IRU Trotter, and Marvin W5IWK Armstrong.

Mikes—Heads—Pickups
(Continued from page 29)

equipment in general is much superior and these machines are capable of handling up to 12" diameter records, and some of them will even cut at dual-speed.

Washington Communication
(Continued from page 12)

Griffith took their stand against it and reported unfavorably. Nettled, the ACA chief threatened to file a minority report and carry the fight before the DCB.

Reason for his interest in labor representation on the Amateur Committee lies in a revelation made in this column many months ago. At that time we told you that the Navy had closely scrutinized, through its Intelligence Unit, the personnel of the ACA. Fearful that there were too many radicals, the Navy made plans to take over the radio posts on all Merchant Marine Vessels in case of emergency.

This item has since been confirmed and Selly is fearful that the Navy may soon move in on his territory. Since so many hams are connected with the Navy and Army reserves, he believes the Navy will attempt to use these men on ships. Therefore, his interest in labor representation on the Amateur Committee.

Best bet: Hardboiled Army and Navy representatives on the DCB will sit hard on ACA demands and leave ham committee for the hams.

By the way, the ARRL named George Bailey to represent it on the Amateur Committee and named the following as regional advisors to the committee: H. L. Cavenes, Raleigh, N. C.; William A. Green, Abilene, Tex.; Kenneth T. Hill, Douglaston, Long Island, N. Y.; J. L. McCargar, Oakland, Calif.; Fred H. Schnell, Chicago; and Dr. Burton T. Simpson, Buffalo, N. Y. The National Youth Administration named Robert R. Burton as its representative, making the list complete except for the American Legion Radio Net.

Nazi Spies in Caribbean

REPORTS have reached Washington that Nazi spies are filtering in to the colony of German refugees which has been set up in Santo Domingo under auspices of the Government of that Caribbean island.

The secret police are said to be mingled in with the legitimate refugees so that it is impossible to separate them. Reports say that the head Nazi representative on the strategically situated island is the local dealer for a German radio distributor. The business is a front, from behind which he directs Nazi agents' activities.

These activities, it is said, include the setting up of a network of small, powerful radio transmitters, which cover Santo Domingo and adjoining Haiti. The Dominican Government is doing its best to check the Nazi activities, but admits it is no match for the Gestapo. There is the hint that U. S. investigators—including our radio investigation unit—may do some quiet checking.

Television Torpedo

THAT "television torpedo" which a couple of radiomen said they had worked out some months ago is laughed off around the War Department as a publicity stunt.

The training programs which the Army is giving rookies drafted into service apparently will answer the need for trained servicemen and operators in the armed forces.

There doesn't seem much chance that professional servicemen will be drafted into service in any numbers, other than as they fall under the *National Emergency* laws.

Defense Orders

OF the billions allocated for defense, the Army and Navy, have spent about 90 per cent of funds thus far appropriated. This is true in radio as in other fields where the Army and Navy have been making heavy purchases.

For a few months now, the contracts will be few and far between. The manufacturers have enough on hand to keep them busy. Later in the year, we have learned, purchases will begin again on a large scale.

The following list of contracts, announced recently, reflects the lull:

Air Communications, Inc., Kansas City, radio equipment, \$101,828.

R. C. A., Camden, N. J., Receivers and Tubes, \$537,968.

Connecticut Telephone and Electric Co.,

Meriden, Conn., for headsets, \$527,533.
 The Horton Mfg. Co., Bristol, Conn., mast sections for vehicular and ground sets, \$159,252.
 Kellogg Switchboard and Supply Co., Chicago, microphones, \$493,000.
 Holtzer-Cabot Electric Co., Boston, headsets, \$57,791.
 Froiland Mfg. Co., Springfield, Mass., mast ports for vehicular and ground sets, \$181,265.

Hammarlund Mfg. Co., New York City, radio receivers, \$43,727.
 Galvin Mfg. Co., Chicago, Ill., receivers, \$18,000.
 Peter A. Petroff, New York City, tuning units, \$21,075.
 Raytheon Production Corp., Newton, Mass., tubes, \$14,813.
 Weston Electrical Instrument Co., Newark, test sets, \$26,101.
 Radio Receptor Co., Inc., New York City, equipment, \$215,016.
 Telephonics, Inc., New York City, headsets (Navy), \$41,300.
 National Electric Co., Malden, Mass., receivers (Coast Guard), \$15,200.
 Collins Radio Co., Cedar Rapids, Iowa, transmitting equipment, \$17,919.
 Federal Telegraph Co., Newark, N. J., transmitting equipment, \$150,000.
 Allen D. Cardwell Mfg. Corp., Brooklyn, N. Y., Antennas, \$14,462.
 Taylor Tubes, Inc., Chicago, Ill., tubes, \$53,199.

Eicor, Inc., dynamotors, \$17,500.
 There seems to be no question of invoking priorities in the radio industry at this point. Deliveries are keeping well abreast of deliveries of planes, tanks, and other equipment for which radio is needed.

FCC to be Investigated

AS we revealed last time, the move to investigate the FCC by a Congressional committee got under way strongly with the start of the new session of Congress.
 The first day of the new session, Senator Chas. W. Tobey of New Hampshire plunked into the Congressional hopper S. R. 20, which would provide for the investigation.
 The ASCAP-broadcasters row has heightened the cry for a probe of the entire industry, as well as the regulating agency. But with the war emergency on their minds, there seems little likelihood that Congress will go off on this tangent in the next couple of months—if at all.

Inauguration Day Net

THE Washington hams pitched in to help the Red Cross handle first aid problems on Inauguration Day, setting up a net connecting emergency first aid stations along the route of the parade. Three mobile stations and a master control station were tied in the net, along with the field stations.
 Those who volunteered for the job included W3IUX, W3IUW, W3HIQ, W3GKP, W3BKZ, W3IVC, W8SVW/3, W3GQM and W3EYX.

Fake SOS Traced

FCC air detectives traced a fake "SOS" call to a New England ham, after the call had caused some havoc in maritime circles. The ham explained that the call was part of a dramatic program, which he was producing to give other hams "code practice." The FCC warned him that next time he cries "Wolf" they'd grab his ticket.
 But the Commission gave a public commendation to the hams who worked to save lives during the recent Texas flood.

Radio-ana:

MILWAUKEE complains that over 50% of the former P. A. business was killed by the formation of Local 494 of the A. F. of L. as a P. A. Union. Seems that the unionists get their equipment direct from the manufacturers who short-circuit the jobbers. . . .
 Also reported from the Beer City is the fact that the Servicemen's Union Local 1092B of the A. F. of L. has made it virtually impossible for a non-union man to work as a serviceman, and the union is taking no new members.

The Army & Navy are very anxious to keep all military movements ultra quiet. To this end they have been "plugging" all newspaper "leaks." Perhaps they would be wise to "plug" the ham-club magazines also, since these, innocently enough, have been publishing all the moves of their members within the armed services. News agencies are keen readers of these little magazines, and use the items as leads to what is going on when all of their other sources of information fail them. . . .

A move is currently on foot to have some of the newer circuits which might be of use to our potential enemies, curtailed in some of the radio mags. . . . Why is it that drawings of ships, airplanes and such are guarded, while hot tips on the latest in radio equipment goes scott-free?

Servicemen are not going into industrial servicing judging by the reports from those manufacturers catering to that particular type of work. But Uncle Sam is interested in developing a group of general servicemen capable of servicing all types of electronic equipment to judge by the radio and electronic courses offered in the Signal Corps.

Electronic Volt-Ohmmeter
 (Continued from page 18)

a new paper scale from a piece of thin Bristol board (obtainable at any printing shop), making it the same exact size as original. Next, lay the original scale on top of new one and take a fine needle and punch through the zero and full scale lines at both upper and lower part of scale ranges. This is to obtain markings exact on the new scale for these positions. The volts scale markings will be easy to make as they are equidistant, but the ohms scale will be more difficult as it is logarithmic. Now take a compass and insert a penholder in place of pencil. (Use wood holder and shave down to fit.) Use an extra fine penpoint and now place the new scale on a cardboard and mark all around its edge with pencil so as to relocate in case it moves. Place compass point in center of lower scale half-moon and in line with the bottom edge of scale. This will give us the correct center of meter needle pivot.

Make the four radius lines for the two scales, and also the volts and zero and full scale lines all in black India ink. For volts scale first make ten equidistant spaces between zero and full scale lines. Then divide these spaces into five equidistant ones.

The ohms scale markings will be in red India ink. In calibrating ohms ranges proceed as follows: Set range switch S4 to "Rx1." Use semi-precision resistors to calibrate this scale. Ten ohms will fall at exactly center scale or in line with 2½ volt line.

If you wish to calibrate your own scale, you must be sure to first short the test prods and quickly balance meter needle to exact zero by means of Zero-Adjust control. On all other ranges it will be necessary to readjust Zero Adjust control as per volts directions. Do not short for long as there will be a noticeable meter needle drop should you do so. After the meter scale has been completed remount new scale paper on the brass plate by means of rubber tire patching cement, as this will not curl the paper as would be the case using glue. Now, your meter and instrument is all ready to go to work for you.

In using this instrument on a.c.-d.c. radios you will encounter some trouble with voltage readings as both this in-



"Here's the Big Book of RADIO VALUES"

FREE
GET IT NOW!
212 PAGES!
EVERYTHING IN RADIO!

85 NEW Knight RADIOS
 See them all—1941's Radio Hits! Models for every purpose—at every price. Plastic and wood mantel models; world-wide sets; "Personal" and 3-way Portables; Recorders; and Phono-Radio Combinations; Auto Sets; Farm Radios; Amateur Receivers—all at new low prices! See them in this greatest of Radio Catalogs!



Save money on EVERYTHING IN RADIO
 24 New Sound Systems, complete P.A. listings; all new Amateur receivers and complete Ham Gear selections; books, tools, test equipment—more than 15,000 quality radio items—you'll find Everything in Radio at Lowest Prices in your ALLIED Catalog!

RADIO BUILDERS!

BUILD YOUR OWN! Count on ALLIED for the latest low-cost kits and help in building any type of radio. ALLIED is Headquarters for Radio Builders!
 New! "Radio Dictionary," Compiled by experts, under ALLIED supervision. Gives concise, easy-to-understand definitions of all commonly used radio terms and words. Only 10c
 The "Radio Builders' Handbook"—valuable beginners' book on radio; easy to understand; illus. 10c
DON'T MISS THE BARGAIN SECTION

ALLIED RADIO

833 W. Jackson Blvd., Dept. 1-C-1
 Chicago, Illinois

Send me your FREE 1941 Radio Catalog.
 I enclose 10c for New Radio Dictionary.
 I enclose 10c for Radio Builders' Handbook.

Name
 Address
 City State

FREE CATALOG



LEARN RADIO

SERVICING COURSE—8 WEEKS
OPERATING—5 MONTHS

H. C. Lewis
I'LL FINANCE YOUR TRAINING

Mail coupon today for free book showing how you can learn Radio Operating, Servicing, Sound and Television in a few short weeks in Coyne Shops and also how you can pay tuition in easy monthly payments after graduation.

LEARN BY DOING
On real Radio receiving and transmitting equipment at Coyne. Simple, easy method of practical shop training. You don't need previous experience. Prepare for Radio Operators' Government License Exam, and for good jobs in Broadcast, Police Radio, Aircraft Radio, Ships, Commercial Radio stations, or in service shops and radio factories. "Learn by doing", the quick, modern way, at Coyne Shops in Chicago.

EARN WHILE LEARNING
Job Help After Graduation

We assist you in getting part-time work to help pay living expenses and give you real employment service after you graduate.

H. C. LEWIS, Pres., COYNE RADIO SCHOOL,
300 So. Paulina St., Dept. 31-3K, Chicago, Ill.

Please send me your free book and details of easy Pay-After-Graduation Plan.

NAME _____
ADDRESS _____
CITY _____ STATE _____

SEND COUPON TODAY

ASSURED STABILITY

WITH
BLILEY CRYSTAL UNITS

10-20-40-80-160
METER BANDS



TYPE B5—This highly active crystal unit for the 40 meter band has less than 4 cycles/mc/°C drift. Price \$4.80.

TYPE LD2—An efficient and powerful low drift crystal unit for the 80 or 160 meter band. Price \$4.80.

TYPE HF2—Simplifies the construction of 5-, 10- and 20-meter transmitters. Drift, 20 meters, 20 C/me/°C; 10 meters, 43 C/me/°C. Price, 10 or 20 meters, \$5.75.

TYPE BC3—A moderately priced mounted crystal with unusual activity and power output. Drift 23 C/me/°C. Price, 40, 80 or 160 meters, \$3.35.

BLILEY ELECTRIC CO. • ERIE, PA.

NEW! 1941 MODEL Pocket
NO Tubes Batteries Radio

DURABLE PLASTIC CABINETS
Dual Bands—Magictenna—Microdial

Fits your pocket or purse. Wt. 6 ozs. Small cigarette package. Receives standard & some short wave. PATENTED POWER RECTIFIER. No tubes, batteries. Hi-ratio easy tuning slide "MICRODIAL". M.L. OF T.L.L. SAYS: "MIDGET RADIO IS THE FINEST" ONE YEAR SERVICE GUARANTEE!

Sent complete ready to listen with instructions & tiny phone for use in homes, offices, hotels, in bed, etc. SIMPLE TO OPERATE—NO ELECTRICITY NEEDED!

SEND NO MONEY! Pay postman only \$2.99 plus postage charges on arrival or send \$2.99 (Check, M. O., Cash) and yours will be sent post-paid. A MOST UNUSUAL VALUABLE ORDER NOW! FREE! "MAGICTENNA"—ELIMINATES OUTSIDE WIRES!

MIDGET RADIO CO. Dept. HG-3 Kearney, Nebr.

SOLAR RED-CAPS

Smaller Diameter Dry Electrolytics

SPEED Servicing

Write for Catalog



SOLAR MFG. CORP. Bayonne, New Jersey

strument and the a.c.-d.c. set negative side will be hot in a certain extent to a.c. line. There will be no direct short as this instrument has a 26,000 ohms resistor R3 in series a.c. line and instrument negative. To eliminate any possibility of a short I've placed a ¼ ampere fuse in each side of a.c. line. To overcome the difficulty with inaccurate voltage readings I made an "isolation transformer" (ratio one-to-one) which I have placed in between the a.c. power supply, and both the Volt ohmmeter, and the a.c.-d.c. radio being serviced; thus isolating the a.c. line. Such a transformer is now recommended by RCA-Victor in servicing all a.c.-d.c. radios in that it is impossible to align most a.c.-d.c. sets except through the antenna lead due to the hum encountered when trying to align "i-f" stages via the conventional first detector. Therefore, such a transformer need not be an extra expense item in the use of my instrument, as it will be needed anyway. However, for those who do not wish to buy one ready made, one can be made up very easily by merely adding a secondary winding to any old filament or power transformer making the secondary the same number of turns as the primary.

A filament transformer is to be preferred as it will require least work. The one I used was one with a 7½ volt secondary. To obtain the turns ratio of the old primary to the new secondary merely carefully check the secondary voltage. Then unwind this secondary and count the turns. To get the turns ratio for 115 volt secondary divide 115 by 7½ or approximately 15½ times the turns on the old 7½ volt secondary. In my case this 7½ volt winding had 60 turns. Therefore, 60x15½, or 930 turns will be needed. I used No. 24 S.C. enameled wire, which will be amply large. Insulate each winding layer with varnished cambric.

Here are some tips prior to calibration and etc. It may be necessary to try from six to ten 50L6GT tubes before a pair is found which has nearly the same characteristics. When a matched pair is found there should be no swing to either side of zero after a warm-up period of five minutes or so. When first turned on one tube may warm up faster than the other and thus swing meter needle either way from zero. If to negative, reverse polarity and try to get a pair that will warm up with the least swing. This will give us a more stable and better balanced pair. Next, set range switch S4 to 5 volt position and connect ground and volt leads to a 4½ volt "C" battery testing with an accurate meter exactly 4½ volts. Then adjust the calibration control R11 until meter reads exactly 4½ volts. There is no need to change this setting until necessary to replace a tube or any defective part.

Before making any voltage tests always be sure to adjust the zero adjust until no change is noted, switching polarity switch to positive or negative. It may be necessary to then adjust the meter needle zero re-set to bring the reading back to exact zero scale setting. There should be no appreciable difference in meter needle when switching from one range to another, although this only applies when the voltmeter cable probe is free from any pick-up source, as it is extremely sensitive.

Herewith the approximate values of single resistances to use in case Semi-Precision resistors are desired in the voltmeter network. These to be made up of necessary individual ones:

Between the 5 volt and 10 volt taps use approximately: 10,500,000 ohms.

Between the 10 volt and 25 volt taps use approximately: 6,150,000 ohms.

Between the 25 volt and 50 volt taps use approximately: 2,500,000 ohms.

Between the 50 volt and 100 volt taps use approximately: 1,150,000 ohms.

Between the 100 volt and 250 volt taps use approximately: 675,000 ohms.

Between the 250 volt and 500 volt taps use approximately: 275,000 ohms.

Between the 500 volt and 1000 volt taps use approximately: 120,000 ohms.

Between the 1000 volt tap and chassis ground use approximately: 115,000 ohms.

The approximate total network sums up to 21,485,000 ohms.

The total network resistance is not of such very great importance but it is imperative that the individual resistances for each range do not vary much from that above or in proportion to total, if different.

This instrument, when using the Rx1,000,000 range, ohms range, is so extremely sensitive that I cannot touch even any part of the test prod handle without making incorrect readings. Therefore I advise the use of the ¼-inch diameter high voltage test lead cable, thereby permitting you to hold onto test lead.

To eliminate hum transfer (modulation hum) to any set on the service bench I've added another Capacitor No. C4 of .05uf and 600 volts across the a.c. line.

Add an Expander

(Continued from page 13)

eration" on your receiver may be necessary. If your set uses a 6Q7 second detector, or 6F5 first audio tube, all connections can be made from the top of the chassis as follows: Take the clip off the top grid cap and unsolder the clip from the lead. Connect this lead to the input of the volume expander, using a short length of shielded wire. Solder the grid clip to another length of shielded wire and connect this lead to the output of the expander. Now replace the clip on the grid cap of the tube. Connect a lead from the radio chassis to the expander chassis and ground the shields of the other two leads.

For sets the audio circuit of which is not accessible from the grid cap on top, connection of the expander requires that two leads be brought out from the chassis. If the set has a single output tube, the alterations are made on the last, or power tube. If the set has push-pull output, the alteration is made on the driver tube.

Unsolder all connections to the control grid of the tube and resolder these connections to one of the unused socket terminals. From this point connect a shielded lead, long enough to reach the volume expander input jack. Another shielded lead is connected from the control grid terminal, from which the other connections were unsoldered.

This lead is brought out to the output jack on the expander. As before, the two chassis are connected together and the shields on the leads grounded.

The expansion action results because of the fact that the gain of the 6L7 can be controlled and varied, depending on the applied bias on the No. 3 grid. When the bias on this grid is made less negative, the gain of the tube increases. On the other hand, as the bias is increased in the negative direction, the gain decreases.

In addition to entering the control grid of the 6L7, the signal is also applied to an amplifier and diode type detector, consisting of two type 76 tubes. The circuit of these tubes is so arranged that the potential applied to the No. 3 grid of the 6L7 will be a direct function of the applied signals. This is accomplished by employing the first type 6P5G tube as a triode amplifier and the second 6P5G tube as a diode rectifier. One potentiometer controls the actual volume of the circuit, while the second, connected to the grid of the first 6P5G tube, controls the degree of expansion.

The additional audio gain produced by the expander unit, when used in conjunction with the audio system of the average radio set, is so great that undue distortion will result unless the unit is properly operated. To assure proper results, the following procedure is suggested: Set the volume control of the radio receiver at the needed level with the expander in operation, but with the volume control on the expander itself turned to the extreme left (near the off position). The expander volume control should then be turned up to where the volume is the same with the expander in operation as it is from the radio set alone when the expander is turned off.

It is advisable to make adjustments of volume with the expander control (the second control knob from the left) turned completely off. Then,

when the volume has been properly adjusted, the expander control should be turned up to a point where the degree of expansion is most pleasing to the ear. The controls need not be touched again.

When programs emanating from some radio stations are tuned, the expander will have little effect. Definite expansion, however, will be achieved in broadcasts coming from the majority of the larger broadcasting stations which are of the high fidelity type. In phonograph reproduction expansion will occur when playing practically all modern electrically recorded discs.

-30-

Radio-Phonograph

(Continued from page 12)

how many must be unwrapped. A handy gadget for determining the correct amount of unwrapping is the "Check-a-loop" made by the Sickles Co. and sold by the radio jobbers.

If a conventional r.f. transformer is available, one that is designed to be used in conjunction with the oscillator coil, it may be substituted for the loop in order to simplify the lining up of the receiver. After the set is operating in normal fashion the loop may be connected and the set operated by this alone in place of the coil and antenna.

If an outside antenna is needed, a one-turn coupling coil may be wrapped around the loop at the outside edge and the antenna and ground leads connected. The grid of the mixer tube connects to the *inside turn end* of the loop. This is important for proper performance of the set.

After the receiver is aligned properly it may be mounted within the case under the motorboard. The chassis can be held in place by tapping two holes, one at each end of the chassis, and the assembly screwed to the motorboard where it will be held securely.

The entire equipment may be carried about with ease. A word of warning: the set works on 115 v. AC only.

TURNER

The Name That Stands for
Reliable Microphones—Offers
TURNER 99 DYNAMIC

First choice of professionals who demand superior performance. The toughest, most reliable mike in the entire Turner line, and the unit internationally famous manufacturers demand for their finest equipment. A sturdy dynamic at only
List \$29.50



22X Crystal Delivers—And HOW!

A stream-lined unit in rich brushed chrome finish. Rugged construction, fully protected, 90° tilting head, 7 ft. removable cable set. Packed with diagrams and with protective mike pouch.
List \$16.50
22D Dynamic \$20.00



Crystal licensed under patents of The Brush Development Co. For complete Free Catalog write The Turner Co., Cedar Rapids, Iowa.



TURNER PUSH-PULL VIBRATORS

Send now for Full Information on this newest development in engineering a advancement!

Amazing New "WALSCO" STAPLE DRIVER

for radio men, electricians or anyone doing stapling. Makes wire and cable installations twice as easy—much neater—saves half the time. Wires can be stapled in corners, behind pipes, into molding—places never accessible with a hammer and ordinary staples. Drives staples even into walls, brick, mortar, etc. Magazine works automatically and holds strips of staples which come in several colors. Ask your jobber for demonstration and catalogue 41-C of all WALSCO PRODUCTS

or write **WALTER L. SCHOTT CO.**
5264 W. Pico Boulevard, Los Angeles, California



New RIDER BOOK

VTVM

You Need This

IF YOU WANT TO GET THE MOST FROM
IF YOU WANT TO BUY THE PROPER
IF YOU PLAN TO BUILD YOUR OWN

Vacuum-Tube Voltmeter

"Vacuum-Tube Voltmeters" presents the practical aspects, as well as explaining the principles underlying the functioning of various classifications of v-t

voltmeters. This book is chock full of information—on theory and practical data—written so it is easy to understand. Order your copy today!

150 Pages—
Hard Covers
Profusely
Illustrated
ONLY \$1.50

OTHER RIDER BOOKS ON VITAL SUBJECTS

FREQUENCY MODULATION

Frequency Modulation is here! This book explains transmission and reception of F-M signals—discusses fundamental principles you will need to know to service the new F-M sets. 136 pages—illustrated—\$1.00.

SERVICING BY SIGNAL TRACING

Servicing by Signal Tracing is used by radio servicemen for locating troubles in every conceivable type of radio communication system. It is fundamental—free from limiting factors heretofore encountered. 360 pages—188 illustrations—\$2.00.

THE OSCILLATOR AT WORK

Know all about Oscillators. Get your money's worth out of them. Protect the investment you have in oscillator equipment and make any future investment in the light of the knowledge this book gives you. 256 pages—167 illustrations—\$1.50.



JOHN F. RIDER PUBLISHER, Inc.

404 FOURTH AVENUE, NEW YORK CITY
Export Div., Radio Int. Elec. Corp., 104 Varick St., N.Y.C., Cable: ARLAB

* * * * *

TRAIN NOW!

FOR THE ARMY, NAVY OR COMMERCIAL FIELD

You, too, can qualify in half the usual time for your amateur or commercial license and a good rating by training in your own home with the Candler System. Candler teaches you code by a simple, practical method—the same easy-to-learn Candler System that has taught thousands including world famous speed champions.

The Candler System has, for over a quarter of a century, shown how easy it is to learn code in your own home and secure a steady, good paying job. Remember the Candler System is the tried and proven method.

Over 5000 expert radio operators will be enlisted by the Communications Reserves of the U. S. Navy. You can qualify for this now—the Candler way.



FREE—Candler's New Book of **FACTS**—Tells you all the inside tips—Get your free copy Now—Drop a postcard today!

CANDLER SYSTEM CO.
DEPT. N-3
ASHEVILLE, N. C., U. S. A.

for WIRED MUSIC OPERATORS

Breastplate "Dispatcher" type. Leaves hands free. Handsome dialectic black finish. Adj. fabric neckband. Choice of single or double headset, high or low impedance. Available total of 12 dif. types and imp. Most attractive, lightweight, rugged, practical chest mike yet devised for operators of wired music units. At your dealer or jobber.



UNIVERSAL MICROPHONE CO., LTD.
Inglewood, Cal., U. S. A.

EVERYTHING IN RADIO

This one big book serves your entire radio needs. It includes sets, parts and supplies, public address systems, amateur equipment, test kits and fluorescent lighting. You'll find the nationally known favorites at the lowest possible prices. Get your copy of this big FREE CATALOG today.



BURSTEIN-APPLEBEE COMPANY
1012-14 McGEE STREET, KANSAS CITY, MISSOURI

RADIO COURSES

Mid-Term Classes Now Starting

- RADIO OPERATING—BROADCASTING
- RADIO SERVICING—a practical course
- RADIO AMATEUR CODE ● TELEVISION
- ELECTRONICS—1 yr. day course, 2 yrs. eve. Day and Evening Classes. Booklet Upon Request.

New York Y. M. C. A. Schools
7 W. 63rd St. New York City

GOLDENTONE... 50% OFF

DEAL DIRECT... FACTORY PRICES... Over 60 models to choose from—4 to 12 tubes. Portables \$3.08 up. Farm sets \$8.98 up. Car sets \$8.98 up. Postpaid band sets \$8.08 up. Samples 50% off. Quantity discounts. Free 1941 Bargain catalog gives details of 10 day FREE trial, agent's proposition and discounts. No obligation. Mail postcard to GOLDENTONE RADIO CO., Dept. R. N., DEARBORN, MICH.



Communication Receiver

(Continued from page 16)

critical in value and may vary quite a bit from the values shown without materially affecting performance, just so they are big enough to decouple and small enough not to drop the voltage too much. Individual minimum bias resistors discourage common coupling through the gain controls, and separate filter resistors are used in all grid returns. These last may be varied quite a bit, but should not be lowered too much or a little regeneration will creep in. Making them higher in resistance will only slow up the a.v.c. action a little.

The r.f. choke used to filter the d.c. blocking pulses in the noise silencer is quite critical in value and had to be shielded in this receiver. Less than 20 millihenries and it refused to take out noise because the circuit oscillated; over 30 millihenries and it quit working by becoming too sluggish.

With the receiver more or less finished, some coils were wired up to try it out. Using the six-prong coil units there are enough contacts so a separate pin can be used for the grid and tuning condenser connections. This allows the use of almost any bandsread method or straight general coverage. I used a small condenser in series with the tuning condenser to give bandsread because it gives an easy method of aligning the coils at both ends of the bands, and if the coils are of reasonably close inductance, the tracking will be good across the band. The actual coils used are regularly available units made for "all-wave" and communications receivers, and are used with air dielectric trimmers. There are several makes available, and for anyone as lazy as I am when it comes to winding coils, they are just what is needed most.

When the construction work is finished, the i.f. amplifier should be lined up using the crystal in a temporary oscillator, or if no crystal is used a 465 kc. signal generator can be used, or the broadcast coils can be plugged in and a signal from the local broadcast station used to line up the i.f.'s. All the i.f. adjustments should be made for maximum "R" meter deflection except the second i.f. plate and detector grid circuits. These two circuits will have to be lined up by ear as they do not affect the a.v.c. circuits. When using the "R" meter this way it would be best to start with the meter at maximum sensitivity (no series resistance) and gradually decrease sensitivity by increasing the resistance in series with the meter to keep it on scale.

In tuning the noise silencer, a weak signal was used and the noise silencer control advanced until the "R" meter reading dropped slightly. The trimmers were then adjusted for minimum "R" meter reading, backing off the noise silencer gain control as necessary to keep the receiver from blocking completely. If too strong a signal had been used here, the second noise amplifier would have been blocked by the a.v.c. voltage and the trimmer adjustments would have had little or no effect.

The general coverage coils are easily aligned either with a signal generator or by tuning for maximum noise

level. They should be aligned first near the high frequency end of their frequency range by adjusting the shunt trimmers, and then tuned to the low frequency end of their range and the trimmer across the series padder in the oscillator adjusted for maximum signal.

In adjusting the bandsread coils, the dial is set near minimum tuning condenser capacity, and the shunt trimmer adjusted to tune the receiver just outside the high frequency edge of the band. The dial is then set near maximum tuning condenser capacity and the series trimmers adjusted to tune the receiver just below the low frequency edge of the band. After this preliminary setting, the adjustments are made at least once more, as the settings of the two trimmers interlock slightly.

Making up the coils an odd thing was noticed about the tuning characteristics of the standard B.C. type tuning condenser used. While the tuning is fairly even on the general coverage coils, the bandsread coils, as first made up, had a far from uniform degree of bandsread. About fifty percent of the band was only using about ten percent of the dial. Stations at the high frequency edge of the band were crowded and could be tuned out by moving the dial one or two divisions; at the low frequency end, a station was still audible after turning the dial fifteen or twenty divisions. This can be largely eliminated by the addition of the fixed condenser shunting the tuning condenser to raise its minimum capacity and lower the ratio of capacity change with dial rotation. The value of this condenser was determined by cut and try and varies with the degree of bandsread wanted and the minimum capacity of the circuit. About 50 mmfd. seems to give good all-around results and saves a new batch of cut and trying for every set of bandsread coils. This condenser can be one of the low drift mica types without doing the frequency stability much damage. The shunt and series trimmers, however, should be air dielectric condensers, for the high frequency bands, at least.

The finished receiver is put in one of the new streamlined black crackle cabinets and has a pleasing and commercial appearance.

Police Radio

(Continued from page 37)

A survey of state police systems reveals there are 32 states using their allocated state frequencies, providing a total of 152 fixed stations, 153 mobile, portable mobile, and portable stations with 61 construction permits.

Washington leads in the number of state police stations having 29 fixed stations, 60 mobile, portable mobile and portable stations with 40 construction permits! Oregon is second with 16 fixed stations, and 9 portable, mobile, and portable mobile.

Twenty-eight of these state and municipal stations are licensed to operate as radio-telegraph interzone stations, and 64 as radio-telegraph zone stations.

This data is reasonably accurate, however due to the increasing number of stations every month, several more stations and construction permits may have been added.

AM vs. FM for Police Service
SINCE the tumultuous introduction of FM to the emergency service in 1940 there has been considerable controversy in the field as to the relative merits of FM and AM as

applied to police communication. It seems as if the FM advocates claimed it was the perfect system and it far surpasses our universally used AM system, but the AM boys say it has been too highly publicized, and as far as they are concerned AM completely covers their territory and they are perfectly satisfied.

We decided it was about time to take down the arguments of both sides and thrash the thing out. This is what the FM gang say about their new system:

Frequency modulation has proved its advantage over AM for emergency service primarily in its noise reduction capabilities providing a more reliable service range.

We do not use high level modulation so we save considerable power, in fact with the same power output as an AM transmitter we can cut our battery drain in half.

Due to the characteristics of FM, we have a perfect AVC system. Changes in signal strength of about 100 to 1 will have no effect on the audibility of the signal from our speaker.

Man-made interference and atmospherics have little effect on an FM signal as long as the interference remains an amplitude modulated nature. Since most of the interference is of this type, the signal remains undisturbed.

Since we do not have to cut the plate voltage of our final amplifier to take care of the peaks, we can operate our tubes more efficiently and get more out of them. Another characteristic of an FM wave is that it takes absolute control of the receiver when it is of a greater signal strength than another signal on the same frequency completely drowning out the interfering signal. This advantage will simplify the problem of frequency allocations.

This is the argument we received from the AM boys. A prominent radio engineer claims, "the carrier doesn't care whether it's wiggled one way or the other, and it will carry a given distance with the same strength providing conditions are good. We will grant FM a certain amount of noise reduction capabilities, but with the universal adoption of the trigger squelch on AM receivers, noise no longer becomes a major problem."

Another argument is: "Most of the AM police installations have been designed to cover a certain area with an adequate amount of signal. With the placement of remote receivers in some difficult cases, reliable 2-way communication is achieved at all times under almost any condition. We do not need a new system to increase our service area and reduce our noise when we are not troubled with noise and we do not particularly care if we can work into the next county or city with our cars."

Another engineer says: "The problem of interference in FM systems is not to be regarded as lightly as one would imagine. Many strong power line leaks and diathermy machines emit waves of a frequency modulated character which would cause interference. Also remember the signal strength to noise ratio of an FM wave must be 2 to 1 to completely wash out all noise."

Summarizing the foregoing advantages and disadvantages we have made the following deductions.

Both AM and FM will hold their respective places in police communication. We believe it certainly would not pay for a department to change to FM if it is being adequately covered with AM.

A small city of a few thousand population where street cars and heavy traffic interference is great, FM, from the standpoint of getting consistent coverage, is greater.

For large cities where man made interference is great, FM, from the standpoint of noise reduction, will serve better.

Large counties, where the service area is rather large, and in a section of the country where adverse weather conditions prevail a great part of the year, would again benefit by using an FM system.

In our opinion this all boils down to the fact that FM does provide a few decided advantages over AM, but it is not of such tremendous importance to warrant any drastic changes in our present AM systems, as far as police radio is concerned.

Serviceman's Experiences

(Continued from page 20)

salesmen most of us are afraid to ask for a fifth of a set's value for repairing it; and, when we work on midgets, that's not enough!"

"He's got something there," I thought, but I did not say anything. Al acts so superior when I let him know I think he's right!

-30-

Servicemen's Legal Advice

(Continued from page 31)

it would be well to let the landlord know for what purpose the store will be used. Merely to say, "Radio Shop" might lead to trouble if the serviceman wanted to put in refrigerators, and, say, electrical appliances. If the location is a valuable one, and the lease to run for a period of years, it will always be better to state your business in more concise and exact terms. Such words as Radio store, radiotrician, service man, radioneer, etc., should be avoided. One of the best descriptions which would cover the entire field of the continually enlarging serviceman, would be to state the purpose for which the store was to be used as, "Communication & Electronic Maintenance, Service, and Construction, such as radio, electrical appliances and the like." Such a description allows the serviceman to engage fully in his business even should he want to make excursions into the field of industrial electronics, which many will want to be doing these next few years.

Light, heat, and fixtures, and who is to furnish them should be specified. Of special interest to the serviceman is to state exactly in his lease that all antennae (he might erect an expensive "beam"), testers, whether attached to the premises or not shall remain the property of the serviceman and he is to be permitted to remove them at the termination of the lease. Failure to so state might induce the landlord to request that since these apparatus are "attached" (nailed to the roof or wall as the case may be) to the premises (store), that he, the landlord is entitled to keep them when the lease runs out. There have been cases where the poor serviceman has had to pay the landlord for the privilege of removing his own stuff when moving. So be sure and mention what you want to be able to take with you.

Above all, do not be frightened by the usual statement made by agents and landlords that "That's the lease, and I can't change it" while he presents you with a paper so finely printed that it requires a magnifying glass to read it. Insist on your rights, and if they are fair, I am quite sure that the landlord will permit you to make the additions and changes to take care of your immediate case. Whenever in any doubt, it will always be best to consult some attorney friend rather than act as your own lawyer, because "he who does his own law work, has a fool for a client, and an ass for an attorney."

-30-

Ringling the Bell

(Continued from page 31)

or another radio station, we can receive and record part or all of your program for you. Special rates. Records can be played on any phonograph and will last for years. Phone 123.

You may not realize it, but there are many people in your town who have not seen close family relatives for years. They would welcome something "different" to send home. An ad incorporating this idea should read:

"Send home a letter by record. Instead of writing your next letter home, talk it on a record and send the record. We have facilities for making records which can be played on any phonograph. Will last for years the same as a

For the Best of Service

OHMITE

RESISTANCE UNITS

Servicemen and Engineers everywhere have standardized on Ohmite Resistance Units for dependable, trouble-free performance. See Your Jobber for:

Cordohms — replace internal voltage dropping resistor in AC-DC radio sets. Also Tapped Cords for pilot lights.

Dividohm Resistors — Easily adjusted to resistance you want.

Brown Devils — 10 and 20 watt resistors for voltage dropping, bias units, bleeders, etc.

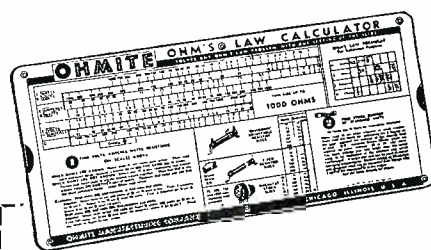

New OHMITE Ohm's Law Calculator

Solves any Ohm's Law problem with one setting of the slide! No slide rule knowledge required. All direct readings. Only 10c to cover handling cost. At your jobber or send coupon.

Ohmite Manufacturing Company
4885 Flournoy Street, Chicago, U.S.A.
10c in coin enclosed. Send Ohm's Law Calculator.

Name.....
Address.....
City.....State.....
Occupation.....

Radio News—Mar.

OHMITE

RHEOSTATS RESISTORS TAP SWITCHES

RECORD CHANGER



Plays 10 12" or 12 10" records. 14" by 14" by 5" high. Crystal pickup. Handles warped records. Will not chip or crack records. Reject switch—automatic or manual change—2 point record suspension. 115 V. 60 cycles. Only 7 seconds to change records.

\$12.95 F.O.B.

UNCUT CONSOLE CABINETS

Send for latest folder

LAKE RADIO SALES CO.

618 W. RANDOLPH ST. CHICAGO

RADIO ENGINEERING

DEGREE IN 2 1/2 YEARS

• Complete Radio Engineering Course in 2 1/2 years. Bachelor of Science Degree. Radio (television, talking pictures and the vast electronic field) offers unusual opportunities for trained radio engineers. Courses also in Civil, Electrical, Mechanical, Chemical, Aeronautical Engineering; Business Administration and Accounting. Tuition, living costs low. World famous for technical 2 1/2-year courses. Special preparatory department for those who lack required high school work. Students from all parts of the world. 58th year. Enter March, June, Sept., Jan. Write for catalog. 1631 COLLEGE AVE. ANGOLA, IND.

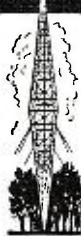

TRI-STATE COLLEGE

RADIO TECHNOLOGY



RCA Institutes offer an intensive course of high standard embracing all phases of Radio and Television. Practical training with modern equipment at New York and Chicago schools. Also specialized courses in Aviation Communications, Radio Servicing and Commercial Operating. Catalog Dept. RN-41.

RCA INSTITUTES, Inc.

A Radio Corporation of America Service
75 Varlok St., New York 1154 Merchandise Mart, Chicago

RADIO ENGINEERING

DEGREE IN 2 YEARS

Intensive, specialized course, including strong basis in mathematics and electrical engineering, advanced Radio Theory and Design. Modern laboratory. Low tuition. Self-help opportunities. Also 2-year courses in Aeronautical, Chemical, Civil, Electrical and Mechanical Engineering. Participation in Civilian Pilot Training Program. Enter March, June, September, December. Catalog.

INDIANA TECHNICAL COLLEGE
731 E. Washington Blvd., Fort Wayne, Ind.

RADIO ENGINEERING,

broadcasting, aviation and police radio, servicing, marine radio telegraphy and telephony, Morse telegraphy and railway accounting taught thoroughly. 48 weeks' Engineering course equivalent to 3 years of college radio work. All expenses low. Catalog free. School established 1874. Dodge's Institute, Oak St., Valparaiso, Ind.

Correspondence Courses in RADIO and ELECTRICAL ENGINEERING

ELECTRICAL ENGINEERING Get good grasp of wide electrical field. Prepare yourself at Low Cost, for secure future. Modern course. So simplified anyone can understand quickly. **RADIO ENGINEERING** Extra fine course in radio, public address, photo-electric work. Training for super-service man, real vacuum-tube technician. Experimental kits furnished. Diploma on completion. **LOW AS \$25** Either course, only \$25. Deferred payment plan available. Write for free copies of school catalogs, student magazines, full details. **SEND NOW!** LINCOLN ENGINEERING SCHOOL, Box 931-R 27, LINCOLN, Nebr.

picture. Call 123 for appointment." For budding local artists, an ad phrased as follows should bring results:

"Make a record of your voice. Hear your own voice for the first time. Sing a song. Speak a piece. Play an instrument. We have facilities for making instantaneous records which will last for years. Call 123 for appointment.

Of course, don't miss selling the parents of your town on the idea of recording their children's voices. A "parents" ad should read:

"Record your child's voice. We have recording facilities to make a record of your child's voice. Can be played on any phonograph. Will last for years. SPECIAL OFFER — 6" record—both sides—only \$1.00."

Capitalize on your ability to make records any place and any time. The following text should bring results:

"We make records any place. We can make a record for you at any location—your home, your club, your school, your business. Call us for full particulars. Phone 123 for appointment."

Finally, if you want to get into a wide-open field, and have a flair for writing continuity, you can offer a "talking-movie" service. Offer to collaborate on adding sound to local home movie enthusiasts' pictures. Full particulars of how this can be done will appear in a future issue of *Ring the Bell*. In the meantime, here is the corresponding ad:

"Make your home movies talk. We can show you how, without great expense, you can have "talkies" in your home. Modernize your home movies. Let them speak for themselves. Phone 123 for details."

Frankly, charges for recordings should be based on "what the traffic can bear." We do not suggest a charge of less than \$1.00 for a 6" record. Studio or shop records should be less-per-minute than records made in the customer's home. Larger records should have a corresponding scale-up in prices. A large quantity of records should be worth a discount over one record. For instance, after making a record, offer the second record to the customer at one-half the first cost.

Finally, let us point out the obvious possibilities of your selling additional phonograph equipment to your record customers. In fact, you will find that you will likely sell one or two recorders a year. Concentrate on those who have children and the ability to buy such a unit. Don't miss sales possibilities to voice and music teachers. (Either records of their pupils, or outright recorder sales.)

Yes, you can make a profit in recordings if you use salesmanship and have patience. You can "Ring the Bell" for additional profits even though you enter the recording field, so to speak, from the back door.

Sound Mixer Circuits

(Continued from page 38)

methods used for controlling the gain, or in the mixing of more than one microphone, etc. He demands as much efficiency in this part of his equipment as he would in its overall audio gain or in getting rid of annoying hum which could be heard through the speaker system.

Microphones are pretty well standardized now-a-days, and they may be divided into two groups: the high-impedance types (100,000 ohms approx.), and the low-impedance dynamics and inductors which are available in 25 or 50 ohms. There are several ways in which we can feed these into conventional equipment, or we can alter the wiring to improve upon the flexibility of the amplifier in many cases.

Fig. 5 illustrates one method commonly used on pa. amplifying equipment to feed a low-impedance source into a grid circuit. A matching transformer is used in order that a step-up ratio may be had for proper match to the grid of the tube. Audio gain is controlled at the output of the tube where the signal is fed to the following grid at a low gain point in the circuit.

An improvement can be made by using the circuit shown in Fig. 6. Note that the tube is connected as a triode. This is used if too much amplification is present for the microphone used. A bias cell has also been added in series with the grid. A potentiometer is used as the gain control at the following tube. The 6SJ7 should be connected as a conventional pentode when maximum gain is required. This is done in the preceding illustrations.

The best arrangement for controlling the gain to the amplifier from low-impedance sources is shown in Fig. 7. This is used by the Broadcasters and Recording Studios. It has the advantage that the input tube is always kept at low operating gain. The signal voltage is considerably less



Careful inspection has been made by British aeronautical engineers of some 3,000 LUFTWAFFE warplanes that have been shot down on English soil by the powerful R.A.F.! Now, highly interesting and authoritative facts on maneuverability, vulnerability, speeds, etc., of Nazi ships have been released . . . startling reports that may be found in a brilliantly illustrated article beginning on page 14 of the big, informative

MARCH ISSUE

FLYING AND POPULAR AVIATION

NOW ON SALE AT ALL NEWSSTANDS!

than with the other methods used for control. If a T pad is used at the input to the transformer, the impedance will be constant regardless of the setting of the pad. This offers the advantage that a line of definite impedance may be used and that there will be no up-setting of this characteristic as the volume is changed.

Fig. 8 shows how two low-impedance sources may be mixed ahead of the tube. Here we have two 50 ohm microphones connected in parallel to a common transformer. Since they are both of 50 ohms impedance, the primary of the input transformer must match the combined impedance, which will be 25 ohms. The T pads are each of 50 ohm impedance. The grid impedance presented to the input grid must not be so high that distortion results. The best units to use are those designed for high-fidelity work. These employ an electro-static shield and this is grounded to the chassis. Some of these have dual and triple shields to further reduce any tendency to hum pickup. The T pads are available in definite volume steps so that the attenuation may be read directly on the dialplate.

Many sound men (no pun) have more than one type of microphone available. Furthermore there are times when a certain type is required that might not be available in a choice of high or low impedance. The circuit illustrated in Fig. 9 may be used to good advantage. Here we find that two high-impedance mikes, and two lows are connected to the same amplifier. The former have individual tubes as voltage amplifiers, while the latter have a common amplifier. Both previously mentioned methods of volume control are illustrated, and the circuit may be added to existing equipment as a separate unit, or if room is available, wired right in to the amplifier.

This circuit, with a separate plate and filament supply, would make an excellent pre-amplifier to be used in conjunction with any high grade amplifier having an over-all gain of 75 db or more.

QRD? de Gy

(Continued from page 35)

cially as it pertains to our American transportation and communications systems, must be dealt with as one would handle poisonous snakes. They must be stamped out . . . and we must lose no time in so doing. Unquote. In our opinion (yeah, we have another) Andy is a real American and we can now understand why this undersized, dried-up radiop has been sent by the membership of the CTU-Mardiv to organize the West Coast radiops. He's a small package of dynamic energy.

INCIDENTALLY, Andy tells us that there are thirty (30) yes, thirty, jobs open on the CTU-Mardiv assignment books. These billets are going begging because of the scarcity of beached members in this organization. It wouldn't be a bad idea to contact them, the Radio Officers Union, 265 West 14th Street, New York City, N. Y., to check up on this information.

SPEAKING of jobs, Brother CB Bolvin, our erstwhile airways sleuth-hound, gathered unto himself a police billet in the fair city of Akron, Ohio. How come, sez we? Well, it seems that Uncle Sammy could use Charlie's predecessor, a Looie in the Ohio National Guard, for one year. So CB hopped into the breach and is sitting right

pretty with \$170 per and plenty of time off. He sez "job consists of acting as a monitor op (all dispatching done by 3rd class ops at HQ) and servicing 70 odd revrs and 15 hifreq xmtrs in the patrol cars". Appropo of jobs, CB sent us "a couple of letters which speak for themselves. Would like to have them back in your next note as I like to wave 'em in front of the noses of some of these guys wot say there ain't no jobs. Pse note that there are just for the past few months". Yousah, gentlemen, there were eleven (11) jobs offered to Brother CB ranging from airways op to handling the shortwave set up for the Firestone Rubber and Tire Co.

FCC please note: Don't you think it's about time that some regulations were adopted regarding the carrying of radiops and equipment on these Lake vessels? In a recent storm which lashed the Great Lakes with 78 mile gale, more than ten boats were either completely demolished with all hands lost, hung precariously on rocks or disabled. For those which had radio equipment and operator aboard, Coast Guard aid was immediately despatched, but for those vessels without any apparatus aboard, the bodies of luckless seamen brought up on the beach by the waves were their only record of disaster. Incidentally, the radio-equipped boats were not carrying apparatus as a legal requirement. This has been going on for many years and it is about time that the safety of human lives should be given some consideration. If insurance companies would refuse to grant insurance on radiop-less vessels, you'd soon see shipowners install the necessary radio equipment. So pse get busy, FCC, and give this a thought.

WE note with pleasure that the CTU-Mardiv have obtained additional 10 to 20 dollar per month wage increases in the Eastern SS Co., M & M, Savannah Line, Carter Coal Co., Atwacoal Transportation, New England SS Co., which set an all time high for coastwise wage scales. Which goes to prove that if you can stick to the line, come what may, you can win in spite of all obstacles in the path. It wasn't many moons ago that a radiop was just a punk who always managed to get in somebody's way, except when the World's series was on or when an SOS was necessary. But today with good wages and Officers status, the old gray mare ain't what it used to be, truly.

THIS Radio Officer Status is a serious business. We note with displeasure that ACA is advocating the absorption of their radiops into the NMU, a seamen's organization. Why this is necessary we do not attempt to analyze inasmuch as we cannot go behind the scenes. But in spite of what is behind the frontispiece we stand firmly on the original ideas which were formed by the organizers of the ACA when it was ARTA; radio officers status, wages and working and living conditions suitable to an officer. Of course, we believe in cooperating with the seamen, we believe that every aid should be given to seamen in their fight for an American way of life, but we do not think it is necessary to sleep with them. If the radiops are absorbed by a stronger and more powerful organization there is no question but that their identity will ultimately be lost and that eventually they will be living in the seamen's quarters. Let us ask this very pertinent question—Why is it that when an able seaman, after years of experience and study becomes a 3rd Mate and receives his license as an officer, he immediately leaves his seamen's union and joins up with an officers' union? His whole attitude changes because he is an officer—some one to be looked up to, some one who has risen above his fellow men by a stronger individuality, a more ambitious interest in bettering his working and living conditions. Yet Radio Officers who have gone thru years of schooling, who have had to study continually to keep abreast of a rapidly changing art, are being asked to relegate themselves to oblivion. . . . Well, why not ask broadcast radiops, ACA members, to go along with their shipside brothers and also be absorbed into a seamen's union? We'd like to hear their reply! Always remember that Admiral

Be a Radio Technician



Learn at Home to Make \$30, \$40, \$50 a Week

Radio is a young, growing field with a future offering many good pay spare time and full time job opportunities. And you don't have to leave home to become a Radio Technician. I train you right at home in your spare time.

Why Many Radio Technicians Get Good Jobs at Good Pay
Radio broadcasting stations employ operators, technicians. Radio manufacturers employ testers, inspectors, servicemen, in good-pay jobs. Radio jobbers, dealers, employ installation and servicemen. Many Radio Technicians own their own Radio sales and repair businesses and make \$30, \$40, \$50 a week. Others hold their regular jobs and make \$5 to \$10 a week fixing radios in spare time. Automobile, police, aviation, commercial Radio; loudspeaker systems, electronic devices are other fields offering opportunities for which N.R.I. gives the required knowledge of Radio. Television promises to open good jobs soon.

Many Make \$5 to \$10 a Week Extra in Spare Time While Learning
The day you enroll, I start sending you Extra Money Job Sheets—start showing you how to do Radio repair jobs. Throughout your course I send plans and directions which have helped many make \$5 to \$10 a week in spare time while learning. I send special Radio training to conduct experiments and build circuits. My 50-50 training method makes learning of home interesting, fascinating, practical. YOU ALSO GET A MODERN PROFESSIONAL, ALL-WAVE, ALL-PURPOSE SET, SERVICING INSTRUMENT to help you make money fixing Radios while learning and equip you for full time work after you graduate.

Find Out What Radio, Television Offer You Mail Coupon
Act TODAY! Mail the coupon for my 64-page Book, "Rich Rewards in Radio." It points out Radio's spare time and full time opportunities and those coming in Television; tells about my course in Radio and Television; shows more than 100 letters from men I have trained, telling what they are doing and earning. Read my money back agreement. MAIL OUT in an envelope, or paste on a penny postcard—NOW!

J. E. SMITH, President
Dept. 1CR
National Radio Institute
Washington, D. C.

Mail this Now FREE
Get 64-page Book
Mr. J. E. Smith, President
Dept. 1CR
National Radio Institute
Washington, D. C.
Mail me FREE without obligation, your 64-page book "Rich Rewards in Radio."
(No salesman will call. Write Plainly.)
Age.....
Name.....
Address.....
City..... State.....

Sims, a few years ago said, "The cream of the Navy are radiomen". So if you are an American radio officer, be proud, hold up your head and remember you can always be a seaman, but a seaman cannot always become a radio officer.

EDDIE TREXLAR, the radiop who, while with the Admiral Sims London HQ Telegraph Corps, despatched the cease-firing Armistice order November 11, 1918, went to his just reward as he was working holiday greeting msg's at WU's Los Angeles office. Brother Trelxar was an old time vet and his many experiences in France during World War 1 could fill an interesting book.

EASY TO LEARN CODE

It is easy to learn or increase speed with an Instructograph Code Teacher. Affords the quickest and most practical method yet developed. Available tapes from beginner's alphabet to typical messages on all subjects. Speed range 5 to 40 WPM. Always ready—no QRM.

MACHINES FOR RENT OR SALE

The Instructograph Code Teacher literally takes the place of an operator-instructor and enables anyone to learn and master code without further assistance. Thousands have used and endorse the Instructograph System. Write today for full particulars and convenient payment and rental plans.

INSTRUCTOGRAPH COMPANY
 Dept. NR, 4701 Sheridan Rd., Chicago, Ill.
 Representatives for Canada
 Radio College of Canada, 54 Bloor St. West., Toronto.

RADIO-TELEVISION

Oldest, largest Radio-Television school in West trains you for good pay job. Complete instruction including Radio Construction and Service, Broadcast Operating, Sound, Talking Pictures, Television, Public Address, etc. Flexible plan to meet specific needs of those with or without jobs. Transportation allowed to L. A. Earn room and board while learning. Request Free Catalog.

NATIONAL SCHOOLS Dept. 3-RN
 Los Angeles

TAKE YOUR CAMERA TO CAMP

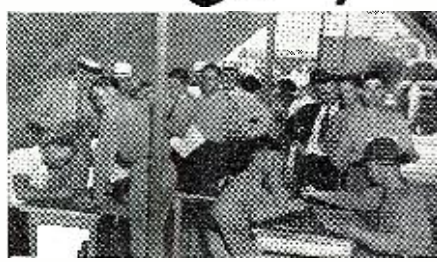

If you're one of the camera fans among the several million young men being inducted into the Army for defensive training, chances are that you've been wondering what will become of your hobby when you doff civilian garb and climb into O.D. habiliments. Don't let it worry you, fellows—you'll be permitted to take your camera with you! What will you be allowed to photograph? What photographic equipment should you take along? Jack Drew, Lieutenant, U. S. Army, answers these and other important questions about taking your camera to camp. Don't miss this authoritative, brilliantly illustrated article in the

MARCH ISSUE

Popular Photography

NOW ON SALE At All Newsstands

So we'll say adieu and calm voyage to that place from which no man returns.

HOW fortunate that we are members of that great fraternity of radiops! This was forcibly proven to ye ed when our dilapidated old hack refused to give after being pushed to Palm Springs from L. A. It was 9 P. M., our money had been spent without thought for the morrow and the jalopy lays down in the small town of Beaumont, Calif. When we learned how much cost to fix from one of the local Jesse James, imagine our surprise, chagrin, etc. to find that money could not be wired in as there was no telegraph office open. So we took our courage in both hands and approached the local gendarmerie, wherein sat 3rd class radiop Geo. E. Childress, as tough an exterior as ever graced a New York copper's map, but with a heart as warm as California's sunshine. We stated our plight, Brother Childress went on the air for a police car, took us to the service station, saw to it that we were fixed up properly, loaned us the money and said goodbye. So if any of you Hams are ever in Beaumont, give Brother Childress a looksee. An tnx agn, Childress.

WHAT the future holds is any one's guess. But there is one thing we do know about the future: that we are going to aid Britain to the fullest extent; that we will make our *National Defense Effort* of paramount importance; that subversive elements, activities and their combined un-American efforts will be stamped out, but definitely. Therefore we ask that every American radiop cooperate with this program, that every American organization do its utmost to wipe out any insipid and illiterate efforts to put obstacles in the path of this program. Our illustrious President Roosevelt states that the Dictator nations will not win this war, which is also our firm belief and hope. But we must all do our share to make this come about. There won't be any room for gold-brickers; we must all work and work together. The country needs you and you and you! So with this for a thought, we say tnx for your loyalty, cooperation and consideration in the past year and may the coming year be one of happiness and continued progress for you-all and your families . . . 73 . . . ge . . . GY

As I See It!
 (Continued from page 17)

tically forced to call the serviceman. By the way was there ever such a day? We don't remember when.

Radio Schematics

ONE problem has been upon our mind for a long time and somehow or other we feel that more than one serviceman, if not many hundreds of them, also have given a thought to the subject. All of us have pondered over many service problems such as charges, methods of locating defects, form of approach, guarantees, etc. One thing however has not been spoken about and that is the ease with which servicemen can interpret the modern day radio schematics.

Now, this subject is not being viewed from the angle of how much knowledge a serviceman may have. For the present we will assume that he has all that he needs, for if he does not, then what we have in mind is doubly important. The presentation of radio wiring diagrams has seen little change ever since the first radio schematic. Is it because what we have today is absolutely the best method? We apologize at the start to those who might feel that we are never content with things as they are; but frankly, we do not feel that the general arrangement of data upon a schematic is as good as it may be—that is, from the viewpoint of the radio serviceman. In fact, we think that

even the radio engineer would like a change from present day methods, to aid him in analyzing the contents and structure of a radio receiver.

As you can appreciate, we have had intimate contact with schematics for many years. Also with many different types of receivers, the receivers themselves and the schematics representing them. Frankly, there were times when we preferred to trace through the receiver rather than try to trace circuit continuity in the schematic, in the attempt to find out just what was going on in the receiver. The receiver was simpler than the schematic.

At times we even wondered about how servicemen who have not had much experience, but who are entitled to make a living were able to follow some of the wiring diagrams. With the tendency towards more complications in the form of television receivers, combination frequency and amplitude modulation systems, inverse feedback, any number of phase inversion circuits, special interlocking arrangements, etc., a modern receiver shown schematically look like sixty different football plays shown in one picture.

Something has to be done along this line. Maybe it is not as important as keeping tab upon how much money is made in the serveshop or how to establish service charges, but most certainly the time spent identifying the contents of a radio receiver reflects upon both. It also reflects upon what knowledge a serviceman secures from his contact with schematics, for to say the least, proper analysis of the processes employed in a radio receiver is a technical education in itself.

We must admit that we are working on the problem—but two, three or more heads are better than one.

National Defense and Radio Men

WE have heard men talk about the tremendous number of radio men being trained under the National Defense Program and the fact that someday when this war is over, or the threat subsides, those men in the Army who were in the communication branch will be available for radio service. Put them all together and the story is that there may be *too many radio men!*

Perhaps that is so, but is it not true that we are entering upon an electronic age, that the possibilities of electronic advances in the next ten years being greater than during the past thirty years are very great. If such is the case, then there is a likelihood that the men who have received radio training will find things to do. Radio and electronics are kinfolk. Radio is the stepping stone to industrial electronics and its myriad other applications. So while we see a very strong threat at first glance, it does not look so bad when we take a closer scrutiny.

Today we speak about 50,000,000 receivers in use and speak about radio servicing with these in mind. We have read with interest the series of articles by *Bohlike* in recent issues of *RADIO NEWS* and there is something really to ponder about. We don't know what the receivers of the future will look like, but there is no doubt that before many years are past, unless the world settles back to the medieval days, 50,000,000 receivers will be but a small number in comparison to the total number of electronic devices which will be in the possession of the public. Who will service these? Who will make them? What will be the effect of television?

Does anybody know? We can guess, but it takes a man with fantastic imagination to envision all of its applications.

Maybe there will be many changes in the radio industry, but service work will continue. We might even say that maybe there will be some change in the status of independent servicemen, but no one knows that definitely. And even if there was some change in the distant future, there still will be servicing.

Take the maintenance men, independent or otherwise,—technical qualification will still count—as it has for all of these years. Struggles there have been plenty—in all fields—but somehow or other, in most cases, the man who *knew* fared better than the men who did not know. Know what? Anything, take your pick. Sure there will be many men familiar with radio, but it has been pretty generally accepted that there have existed during the past decade more than 100,000 men familiar with radio and have done service work, but of this large group only about 30,000 at tops have represented the practicing service group. So, if in the future there will be 250,000 or even 400,000 radio minded men, the volume of radio or electronic work will be capable of keeping 100,000 busy, so that the ratio we find today may hold in the future.

Legal Advice

THIS radio servicing business is in many places anything but picayune. Many shops have reasonable investments, not only in servicing equipment, but in the general contents of the shop so that if they do become the target of a suit, collection is not an impossibility. If the scope of service activity will increase as is intended by a series of articles now appearing in RADIO NEWS, the dollar value of apparatus handled will be greater than heretofore, hence anything which will tend to guard the financial safety of the service shop owner is worthwhile.

Many servicemen buy much material on "time," so that contracts are involved. Many servicemen assume responsibilities when they sign contracts to do work in bulk for other organizations. That slip of paper which does not have much significance when everything is fine, can become tremendously important when dissension arises. We do not recommend that servicemen make out their own contracts. After all lawyers too have to live, but no harm is done if the serviceman has some idea of what he is signing and knows the difference between a chattel mortgage or conditional bill of sale and the libretto of an opera.

So we say, that dry or not, it pays to read these legal discussions. It's a part of the magazine—you paid for it, so why not get as much out of it as you can? An ounce of prevention is worth a pound of cure. —30—

Aviation Radio
(Continued from page 23)

sonnel, research, etc., all go to make up the "safety factor."

Generally, it could be taken to mean the over-all factor that keeps the aircraft in the air, "in flying position." However, a "cut and dried" definition could be: "Safety factor is that which guards against possible harm by utilizing every means to prevent injury to equipment and operating personnel."

However, safety factor has many varied definitions, and I sincerely don't believe that there is a standard one for it, because it covers too much territory.

Data

IF additional information is desired by a reader, concerning any piece of aviation radio apparatus or device; or if you have a special problem, a card dropped to Aviation Radio, at RADIO NEWS will bring the information to your mail-box. —30—

Ham Chatter
(Continued from page 35)

During a recent Sleet storm ham radio was the only outside contact in North Mo. Southern Iowa. W9AG, W9SRE myself, W9OOI W9PEO, W9YYW and other amateurs handled quite a bit of important traffic that otherwise could not of gotten through. W9PGE and myself secured a Dr. for an emergency operation.

W9OOL now has his Class A and Ted is doing fb down on 75 phone.

W9DIZ, and W9CPR also have new Class A tickets.

W9IMZ has up a balloon type antenna and it works out fb. I plan on trying one of these soon as possible. Bob says 125 ft # 18 wire works out better than the longer wires with the balloon.

W9CVS formerly of Dallas City, Ill., now has a fb rig at Culver Stockholm College Canton.

W9JXU is a new ham on 160 meters at Quincy, Ill.

The 10 meter band has been in very poor condition here for two months. Very few sigs, coming through, some days none. 160 meters has been better for 5th district, most times they are louder than 9's.

"HAMGAB." Hamfester's Pub. says:

John W9RBR Nelson is missing an upper grinder in an unfortunate encounter with the icy sidewalk. Trying to catch Ben W9ENX Hesper's puzzle jumper to retrieve his keys after the meeting of December 6th. Johnny made a one point landing, and sacrificed the upper flap.

We suggest W9ENX take a course in memory training.

Bill W9JID Guilmont, after rebuilding the Collins final with TZ40S, will soon have a pair of 'em on CW in another rig. We've seen the CW heap and it looks like the WAS party will be duck soup!

Joe W9FIB Haenle, who won the Howard 490 at the Picnic last August, finally got the receiver last week. He says it works FB.

Madam W9GFG Mike Zwoster and Wade W9IMB Holcomb have been called to active duty in the Navy. Mike is stationed at San Diego, on shore duty. Wade is aboard ship.

One of our scouts reports Everett W9JLA DeBeck in a jobber's store looking over a new frequency meter.

Three more graduates of Nate K9UVU Heaton's code class recently received their long awaited tickets from FCC.

Any of youse hams or youse gals who fancy yourselves as checker players should see the Director of Hamilton Park. They plan to start a checker club soon. The grape-vine has it that Hamfester Jack W9PSP Stanton will soon be officially appointed the new Emergency Coordinator. Jack's ideas should bring the value of amateur radio to the attention of those who sometimes think of hams as the "seek you" boys. Give Jack all the help and co-operation you can in his important job.

Wayne W9HWN Douglas is trying to promote an oscilloscope. He heard of one ham who uses one and has worked every district but W6. Pretty good DX for an oscilloscope!

Two of our W.K. members have a unique (?) scheme for eliminating interference. Tom W9CNI Powers and George W9SXZ Fenton, both on 80 meters worked cross-band the other day. Each was tuning the other's harmonic. Swell bizness!

Back home again having finished his enlistment in the Army, Nate W9UVU Heaton's . . . son Eugene is telling his Dad all about Alaska . . . Boy, what a swell spot for a fundamental antenna . . . 80 meters C.W. seems to be the band at present. Quite a number of Hamfesters are back there and are having a lot of fun, at the same time boosting up their code speed for the ARRL certificates.

Virgil W9KVY Minnick worked NAA on 5865 KC recently but insists he didn't have to get on NAA's frequency to do it.

Les W9KBO Morey reports some nice contacts since his XYL dusted the rig and got it all out of tune.

Wedding bells will ring out soon at the W9IWX Wembers, Dorothy will "centerstage it" on February 22nd.

Chuck W9AUK Kugel got Class A ticket and is now on 20 meter fone.

J. B. W9MUZ Maloney much pleased with his RME-69 and DB-20 combination.

Warren W9RRC Keller says his Indianapolis Convention pictures are not ready but promises them soon. He offers to withhold any of them if he is paid his price.

Warren W9YDV Clark, Howard W9HKB Hinman and Jack W9PSP Stanton met recently with Dr. Ember, Chairman of the Disaster Committee of the Cook County Council of the American Legion to discuss tie-up with Amateur Emergency Corps. The Legion is taking increasing in-

There's MONEY FOR YOU in the P.A. field!



• The term "radio" covers a wide field of opportunity. One important phase of radio work is the installation of P. A. (public address) units, and their operation, servicing and maintenance.

It takes trained men to install, operate and service public address systems in ball parks, auditoriums, stadiums, theaters and sound trucks—and experts in this field make real money!

The I. C. S. Sound Technician's Course is designed for radio servicemen and radio service engineers; installers, operators and servicemen on public address systems, sound amplifiers, centralized radio systems; those engaged in the development, manufacture, installation and maintenance of electronic equipment such as automatic traffic control, sorting machines, noise measurement machines, etc.

FM AND TELEVISION

All five I. C. S. Radio Courses (see coupon) include Frequency Modulation and Television—subjects you *must* be familiar with if you wish to cash in on tomorrow's opportunities. These Courses are prepared by leading *practical* authorities—they are profusely illustrated for clarity—and their worth has been proved by a multitude of successful graduates now making big money (many with their own businesses)!

One of these I. C. S. Radio Courses, or a combination, may fit you for bigger earnings than you ever dreamed possible!

MAIL THIS COUPON TODAY FOR A BRIGHTER TOMORROW!

INTERNATIONAL CORRESPONDENCE SCHOOLS 1891 ★ 1941

Box 8280-W, Scranton, Penna.

Explain fully about your course in the subject marked X:

GENERAL RADIO PRACTICAL SERVICING

RADIO OPERATING SOUND TECHNICIAN

SOUND-PICTURE PROJECTIONIST

Name..... Age.....

Address.....

City..... State.....

interest in emergency and defense work which should lead to additional opportunities where hams can be of service.

R. F. (K5AY) Gaudreault ships us:
Our local oracle has again changed QTH as call letters. Now located at Quarry Heights CZ with the rest of the BPS at K5AY.

K5AT's gift to the women, old Coca-Cola Mac is abt to become a has been dwn hr. due to return to the old country nxt month. Op taking his place. Guy by the handle of Frank Sines es seems to be a pretty gud spud fm hr. Don't tell him we said so.

K5AK bck on air after long period of silence. Sum op dwn thr at Amador finally got the whistle back together es bn wkg out fb wid it. Can usually be hrd in the pm fr few hrs.

We saw a pair of Staff Sergeant Chevrons walking around here the other a.m. es sent a member of our OGPU staff out to see who was under em. We found a bp who shud be pretty well knw to all the brass destroyers es mlke men. . . . Bray out thr at K5AM. Congrats, Bray, om, es bests fm the gang at the heights. We got our share of em too!

Was the gang at K5AG humiliated? Well, we ask U! A ticket for clix es chirp fm the RI m. of all places, Seattle Wash. Wat u guys using dwn thr in Redleg Camp, a Calif KW? Well at least u knw ur getting out nw. But think of the rep of the K5 oil burners hr. Wat abt it men, leis get it stuff out of thr. We knw u can do it es still get it whistle up thr to Seattle so the RI wont even recognize it!

Once again fer u guys who want K5 crds, the hours of xmission hr are fm late in the afternoon to arnd nine or ten pm. We wont bother to give u the exact time becuz sum of the boys may get overzealous at times es miss the deadline a bit and who are we to be a killjoy? Only stn supposed to be on the ether at all times of the day or night is K5AY es we'll usually oblige and Steinmetz Junior who wants to see it K5 hang-

ing up thr in the shack. U'll find us on 7160 wid a sig t'll get anywhere.

Hws abt sum info fm sum u oms who burn the midnight oil? Has KC4USA got a 40 mtr freq? If so where is it? And when can he be wrkd? We'd like to buzz the boys in the Berg Country es we have sum fellow soldiers dwn thr who'd be glad to hr fm us.

One our ops hr guy by name of Wedding who sined O nw gone to civilian life to wrk Civil Service for Pan canal. Hrs Luck, Wed, es drp in on the gang sumtime efen ur not gng zonite on us!

Anybody ever hr an HN2 If so where are those things located? Hrd one hr es cudn't even find anything it looked like it in the book.

Last week we inaugurated sumthing hr which might interest sum of u people who want K5 contacts. Every Sunday am fm 0700 to 1000 gmt we'll wrk an alert solt who'll lissen on 7160 kc allowing abt five mins per contact. Just lissen fer our QRZ? After each contact es jump on. Don't get impatient becuz it's impossible to wrk all at once. But we'll get all we can in tr time. The service is to furnish u a ck on ur whistle for both strength es quality. U can depend on our rpt becuz it'll be as accurate as the best in receivers can give u.

If NY1AE wanders across ur eardrums sum fine night, don't worry he's right dwn hr in the naval part of this combine. Located at Pedro Miguel, es other nite was first time we hrd him in long time. Doesn't sound so strong fm hr but seems to be getting out fb to west north and central us.

QRM from the 5th Dist. by W5HMY Windy Bill:

An informal but FB ham fest was held recently in McComb, Miss. Among those present was W5HMY, W5GXO, W5DAN, W5EGE, W5EWD, W5FQL, W5FCH es W5IGW also plenty SWLS hi. The meeting was held at the fire station in McComb City.

W5IGW was really suprised when he met W5DAN the Pappy of 75 fone. W5EGE is an old timer on CW in Brookhaven, Miss. Ben has never been on fone and what's more says he never will be on Ben is the checker champ of the fire house in Brookhaven the games are held every Sun. morning hi.

W5IGW is the proud possessor of two cypress poles 90 es 75 ft. tall. Harold lives in Greenville, Miss. on the Mississippi River so what does he do but go up the river es cut himself a couple of giant poles had them towed down to his town then had to pick out a special route thru the streets that had wide corners and as it was he knocked over a couple of mail boxes then Harold bought a qt. of likker and two cases of beer and the Light Co. boys did the rest.

W5GXO thinks 40 ought to be opened up for fone work.

W5DAN was the gracious host at a luncheon held in McComb, Miss. recently, the guests of honor being a certain fat boy and his batelaxe.

W5FCH bought himself a FB new RME, Jake says it really brings the sigs in.

W51RW is a new and distinctive signal being heard on 160 fone Dale has a pr 812z in the final es runs 300 watts.

W5BZL in Del Rio, Tex. on 40 has another nice carrier.

W5JZB is a new comer on 160 welcome hi.

W5JEY old Hershel in Winnsboro, La. is also a new comer on 160.

W5JFS is a brand new ham in Baton Rouge, La. his handle is Floyd Crum es he is looking forward to becoming known as the crum of 40 cw hi.

W51GQ in Homer, La. is now heard on 160 James has a fb mlke voice.

W51YG works 10 fone from Lake Charles, La.

W5HRX the old CW man from Gulfport, Miss. is now one of the fone boys.

W5HPI the old pea picker up in St. Joseph, La. is using a T55 es running 120 watts.

W5JDZ in Colman, Tex. is on 160 fone wid a healthy signal.

W5HOT es W5HQV are still holding their early morning rag chews.

W5FPU is really a State Pen Harry who is located at the Ark State Pen Harry is not an inmate of said institution however but is chief accountant up there hi. Harry has a convict house boy named Chick which he puts on the air and he is really a kick.

W5HMY was riding down the street in Baton Rouge, La. one day when he noticed a car up in front of him with the call letter W9AOV on it not having a horn on his car WHMV tapped out hi with his acclerater pedal and drove on 3 weeks later he called CQ one morning and lo who comes back to him but 9AOV who had just got back from a visit down south and was back in Cuba, Ill. George was really suprised when he found out 5HMY was the guy who had blew hi. at way down in Dixie.

W51BY John in Houston, Tex. is one of the outstanding sigs on 75 fone.

W5CEW in Benton, La. is a regular on 75 fone also.

W5GEP in Corpus Christie, Tex. is an early bird DXer on 160 fone.

W5EBV at last report was still enjoying an extended vacation hi Dan.

W4AV5 is back on the air with his usual fb sig.

W5HMZ says he wishes he had a good rig like Windy Bills.

W5GIZ now has more licenses than a dog has fleas.

W5BLQ Jack Gaines in Amite, La. is back on the air after a long absence.

MORE QRM from the 5th District by W5HMY Windy Bill:

Well we will start this month off by asking the Ed. why he can't get the pictures and dope on the aforesaid pictures to-gether in the same

issue which brings to mind the thot why he pays for this stuff any how hi.

The following story is currently being told on 160 by W5EPR, seems like one of Gayles neighbors recently purchased a new radio and came to see Gayles about putting up and ant he said he had often heard BCI talked about and what he wanted to know was what direction should he put up his ant in order not to cause W5LFR any trouble Gayle staggered and gulped and told him that since he was so nice about it to go ahead and put it up any way and he would take his chances. (Shoot the sherbert to him Herbert.)

Once upon a time there was a ham by the call of W4HKJ in Kentwood, La. about 30 miles from McComb, Miss. now one Sunday W5HMY visited W5GXO in McComb and while there 5GXO called and contacted 5HKJ after a Xmission from 5HKJ 5HMY took over the mike and asked for a comparative report 5HKJ thinking 5HMY was at his home base in Baton Rouge, La. proceeded to give 5HMY Q5R9 es 5GXO Q5R7 while they were both talking over the same rig. (Some fun eh kid.)

W5IKP is trying to get W5HHT to show and tell him how to get a good sig on the air.

W5FHS in Overton Tex. really puts out a sig on 75 fone.

W5GUX es W5HHA are two new comers to McComb, Miss. they are connected with the CCC Hqs. that was recently moved from Camp Beau-regard La.

W5AOZ is another Bill on 160 fone in New Orleans, La.

W5HZP of Houston Miss. said he recently got a letter from the Texas chamber of commerce asking him to please state he was in Houston Miss. on his Xmission.

W5JAH of Lake Arthur La. is going to town on 160.

W5BV bought 6 RN when he found out his profile was in em.

W5DHE will soon have his kw on 75 fone in B.R.la.

W5JGP of Biloxi, Miss has joined the navy.

W5HMY was a recent speaker over WWL BC and gave his opinion on the situation of B.R.La.

W5HCE says if there were enough hams in town he could get on the air hi.

W5EKV of Brookhaven, Miss. is an AUTHOR no less.

SOME of the boys are wondering who that new Y1 of Mack's is in of 'Alabam'. He goes the gal purty often: don't tell us tt new rig needs t many rpts fm the same place, pal!

K5AS can promise to have sum gud tales to spin in next rpt becuz he collared assignment to cover election in Panama by radio fer Army hr es those things are usually anything but Sunday school picnic; so u can all luk fwd to hearing sum tall tales if yours truly cums thru wid whole skin!

A bit of interesting info abt K5AT agn. Mack does fb job on special duty grabbing war news out of the ether for the info of military personnel hr. His job is to sit up at the shack all day es rabbit hunt fer all war news cuming thru fm press wireless es others and pounding it all out on the mill. Bn it es getting requests played by best squirter HP5K-HOK in Colon, discussing his mode-julation bn cokes, Mack's much too busy for any repetition of those adventures in Colon which led to much gleeful discussion of his 'black gal' arnd Birmingham's gashouse circuit.

-30-

Video Reporter (Continued from page 41)

dent even before commercial birth.

WHILE New York television programs are continuing on an abbreviated scale at the time of this writing, the program lads are not going to any too much trouble to weigh the entertainment value of the stuff they're putting on.

They're making a mistake in continuing certain types of programs just because they're free. Sporting events, in particular, are being proportionately overdone. It's true that sports will always be an acceptable program topic, but the reason for the great proportion of sports pickups at this stage is that there are no talent fees to be paid.

Excellent pickup jobs have been achieved in various sports, particularly in wrestling and boxing. We'd hardly call wrestling parlor entertainment. Discounting the claims that wrestling matches are not as brutal as they seem, the television camera and mike take the home listener right into the ring to hear the grunts, groans and snorts of the hirsute gladiators which may convince him that the men are going through terrible ordeals. But, all in all, the wrestling matches are tougher on the look-and-listening air audience than to the men tied together like pretzels on the mat. It makes for good comedy, but we'll bet a peanut to a potato chip that the *Legion of Decency* will swoop in from Hollywood to make the boys on the mat keep their grunts clean.

-30-

Classified

Rate 15c per word. Minimum, 10 words.

CORRESPONDENCE COURSES

AMATEUR Radio licenses, training in code and theory. Resident and home study courses. Hundreds of licensed students. American Radio Institute, 1123 Broadway, New York.

USED Correspondence Courses and Educational Books sold or rented. Inexpensive. Money-back guarantee. Write for Free Catalog listing 4000 bargains. (Courses Bought.) Lee Mountain, Pisgah, Alabama.

CORRESPONDENCE courses and educational books, slightly used. Sold. Rented. Exchanged. All subjects. Satisfaction guaranteed. Cash paid for used courses. Complete details and bargain catalog free. Nelson Company, 500 Sherman, Dept. C-237, Chicago.

PATENT ATTORNEYS

PATENTS—Advice and booklet free. Highest references. Best results. Promptness assured. Watson E. Coleman, Patent Lawyer, 724 9th Street, Washington, D. C.

PATENT your idea. New, useful ideas often very valuable. Two books—free—tell how to apply for patent protection—give six basic ways to sell your invention. Experienced patent counselors. Fees reasonable; deferred payments. Write today. Victor J. Evans & Co., 429-C Victor Bldg., Washington, D. C.

INVENTORS—Before disclosing your invention to any one send for Form "Evidence of Conception"; "Schedule of Government and Attorneys' Fees" and instructions. Sent free. Lancaster, Allwine & Rommel, 414 Bowen Building, Washington, D. C.

INVENTORS—Don't delay. Protect your idea with a Patent. Secure "Patent Guide" and "Record of Invention" form—FREE. Preliminary information furnished without obligation. Write Clarence A. O'Brien, Registered Patent Attorney, 1C17 Adams Building, Washington, D. C.

PHONOGRAPH RECORDS

PHONOGRAPH Records 10c. Catalogue. Paramount, FD-358 East Market, Wilkes-Barre, Pennsylvania.

PHOTO FINISHING

ROLLS DEVELOPED, two prints each and two free enlargement coupons, 25c. reprints, 2c each; 100 or more, 1c. Summers Studio, Unionville, Mo.

RADIO ENGINEERING

RADIO Engineering, broadcasting, aviation and police radio, servicing, marine and Morse telegraphy taught thoroughly. All expenses low. Catalog free. Dodge's Institute, Elm St., Valparaiso, Ind.

RADIO

USED Radio merchandise. Bought. Sold. Exchanged. J. C. Thimijan, Lake City, Minn.

RADIO Kits—\$3.95 up. Single band; all wave. 5-10 tubes. Fluorescent lighting. Save 50%. Radio-parts catalog—FREE. McGee Radio, P-2075, K. C. Mo.

What's New in Radio
(Continued from page 27)

net itself.

Associated Attleboro Manufacturers, Inc., mold the cabinet for Rada Radio & Electric Company, Plastics Division, Monsanto Chemical Company, supplies the material.

Allied introduces new Knight Radio Tube line. A new line of Knight Radio Tubes is currently being featured by Allied Radio Corp., Chicago. Built to exacting standards and specifications, these new tubes have created a stir in the radio industry. This is true for three principal reasons. First, because of the adherence to strict standards in the manufacture of these tubes, engineers have been able to develop in the Knight line tubes which have become famous for high quality, superior performance, and long-life dependability. Second, these tubes, although high in quality, are available at most attractive net prices to dealers and servicemen. Third, every

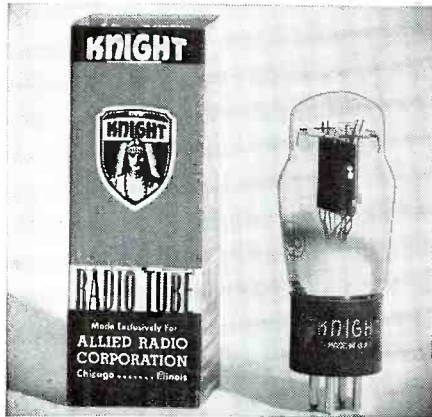

Knight tube carries a replacement guarantee covering any electrical or mechanical defect for a period of 6 months from the date of purchase. In addition all tubes are R.C.A. licensed and incorporate the latest developments in vacuum tube design and characteristics.

The Knight line of radio tubes offers a wide selection of the latest type tubes in all-glass, all-metal, oetal base glass, miniature, and GT oetal base types. All tubes are supplied in attractive factory-sealed cartons. Special quantity prices are available.

The new Knight radio tube line is a feature of Allied Radio Corporation, 833 W. Jackson Blvd., Chicago, Ill.

New SHURE 44A Magnetic Recording Head. A high quality wide-range record cutter with many advance features is offered by Shure Brothers, Chicago.

This new Shure 44A Magnetic Recording Head is ideal for use with home recording equipment. It is designed to operate directly from the voice-coil winding of the output transformer. Stiff moving element permits recording on practically all recording materials. Records can be played back on any record player. The 44A is very rugged and stable—designed to give long, satisfactory service under all climatic conditions. High sensitivity. May be operated from the output stage of almost any radio set. Impedance: 10 ohms at 400 cycles, 4 ohms D.C., suitable for output circuits having impedance of 4 to 8 ohms. Other impedance values are available on special order. Steel, alloy-tipped, or sapphire recording styli may be used. .36" flexible leads. Length overall 3 3/4", less screw 3 1/4".

Shure Brothers, Microphone Headquarters, 225 W. Huron Street, Chicago, U.S.A.

Audio Devices Inc., 1600 Broadway, New York City, announces a new and considerably improved line of cutting styli for the critical recordist. More careful inspection and a new manufacturing procedure coupled with scrupulous adherence to detail has produced a styli with a noise level several db quieter than ever before. The high frequency response is definitely improved and is of considerable interest to studios and broadcast stations now using the newest type of extremely wide-range cutters. For convenience in operation the thread throw has been increased and improved.

Heriolofoye sapphire and stellite AUDIOPONTS have been individually "recording tested." New tests have been devised to insure the new features of these styli as well as to assure delivery of a truly reliable cutting point.

The Turner Co. of Cedar Rapids, Iowa, long recognized as a leader in the radio parts industry, is announcing a new product added to their line—the Turner Push-Pull Vibrators.

These Vibrators offer 10 engineering advancements designed to free the industry from customers' complaints, and to keep users happy. Turner Push-Pull Vibrators do not depend on the spring action of the steel, but instead, employ an equal amount of magnetic power to Push, then Pull the reed and its contacts. The resulting harder-faster swing of the reed gives

a cleaner, more positive contact every time. Piling and chattering are eliminated and R. F. Hash reduced. Mechanical noise takes a real licking with this new Vibrator, which also gives more stable operation, longer service, with low drain and high output.

Another new feature to be found in Turner Push-Pull Vibrators is the micro adjustment of the contact points, which takes place at the factory. Adjustable screws, held in place with lock nuts, permit this precision adjustment at the factory, and assure sure-fire operation of the unit when delivered, thus eliminating extra servicing.

Completely revolutionary is this Vibrator which eliminates the old-type stack assembly. Instead it offers a 100% closed dual magnetic path with its resulting increase in efficiency. This doing away with the stack type assembly also eliminates the cause of short circuits from deteriorated or slipping insulation.

Turner Push-Pull Vibrators are packed in factory-sealed cartons to assure users of new merchandise. These cartons have open terminals for testing the vibrators without removing them from the carton. They are Guaranteed for One Year by the same manufacturer who makes Turner Microphones, and are available in models to meet all replacement calls. Turner Vibrators are distributed through jobbers all over the United States. Those wishing a Free Manual or further information may write The Turner Co., Cedar Rapids, Iowa.

The Carter Motor Company of 1608 Milwaukee Ave., Chicago, makers of Dynamotors and Converters for Aircraft, Police, Marine Radio, and general use since 1932, announce the purchase of the Magmotor Police Radio Power Supply Division from the American Bosch Corporation of Springfield, Massachusetts. All patents covering permanent magnet Dynamotors together with tools, dies, patterns and trade marks, become the property of the Carter Motor Company who will maintain full service for all former American Bosch customers.

The Magmotor is unique in principle; no field coils are used. Alnico permanent magnets take their place, increasing efficiency, reducing size and weight, and eliminating heat. Magmotors will run continuously for more than 5,000 hours before brushes require changing. They are the ideal power supply for frequency modulation Police Radio.

The Magmotor addition to an already large line of Dynamotors and Converters makes the Carter Motor Company the sole manufacturers of permanent magnet Dynamotors. Licenses under the permanent magnet Dynamotor patents will be available to others.

RCA Manufacturing Company, Inc., Camden, New Jersey, announces the Radiola 515, a pow-

SPRAYBERRY TRAINS YOU for GOOD PAY! STEADY WORK! ADVANCEMENT! in RADIO and TELEVISION

DON'T WAIT! START NOW!
You Can Make Money Almost At Once
You'll be quickly shown how to get and do neighborhood Radio Service jobs... for practice and profits. You easily learn Television, Frequency Modulation, Signal Tracing, Mobile Radio (Auto-Tank), Aviation Radio, Electronics, Facsimile Radio, Radio Set Repair and Installation Work. I'll Prepare You Quickly In Spare Time

At Home Or At Camp
SPRAYBERRY Training does not interfere with your present work. You will receive personal coaching service all the way. You'll be fitted to hold down a good paying job in Radio or to have a Radio business of your own.
You Get Professional Test Equipment
... Plus Experimental Outfits
Includes 148 RADIO PARTS (to build complete Radio Receiver), RADIO TOOLS and a TESTER-ANALYZER. MY EXPERIMENTAL OUTFITS enable you to conduct actual experiments with your own hands.

NO EXPERIENCE NEEDED
It makes no difference what your education has been. I can fit you to become a real RADIO TECHNICIAN. Your success is my full responsibility.
THE SPRAYBERRY COURSE IS SOLD UNDER MONEY-BACK AGREEMENT

RUSH COUPON for BIG FREE BOOK

SPRAYBERRY ACADEMY OF RADIO
F. L. Sprayberry, President
425-C University Place, N. W.
Washington, D. C.
Please rush my FREE copy of "HOW TO MAKE MONEY IN RADIO."
Name..... Age.....
Address.....
City..... State.....
(Mail in envelope or paste coupon on penny postcard)

RADOLEK'S NEW 1941
FREE! "RADIO PROFIT GUIDE"
Brings You Hundreds of BARGAINS Like This One!
GET THIS BIG FREE BOOK OF EVERYTHING NEW IN RADIO AT Bargain Prices!

Shows hundreds and hundreds of up-to-the-minute radio parts, sets, accessories, ham gear, electric appliances and supplies. Indispensable to every amateur, experimenter, set builder, sound engineer and serviceman. Keep up with radio and all its phases—send for the big FREE Radolek Profit Guide now! **DON'T WAIT—SAVE MONEY AT RADOLEK.** Address Dept. B-52.

RADOLEK COMPANY
601 West Randolph Street
Chicago, Illinois

Special Value!
Professional Type
HOME RECORDING DISCS
(Heavy Metal Core—Non Flammable)
10" only 19c each
Made by foremost manufacturer. Proven equal or superior to any discs of this type regardless of cost. These blanks have very slight imperfections but guaranteed to make perfect recordings or your money back. Coated on both sides. Big savings!
6" Discs—10c; 8"—14c; 10"—19c;
1c less in 25 lots.
Send no money—shipped C.O.D. plus postage.
Order Today!

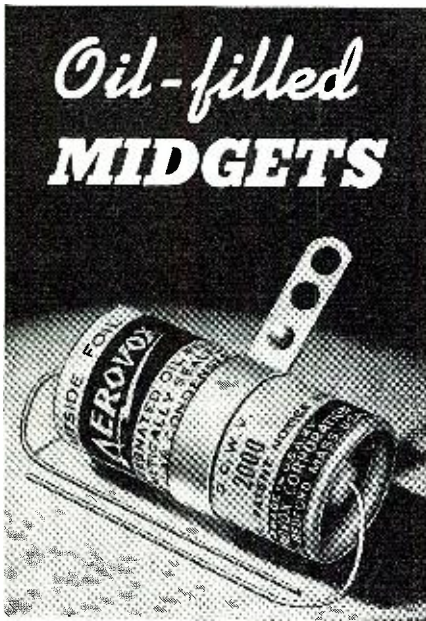

Originally made special to meet the rigid specs. of Government and commercial-communication buyers, this midget oil-filled condenser now becomes a standard item at a mighty low price. Ideal for vibrator applications, coupling, low-power transmitters, high-power amplifiers, and for severe-service test equipment. Hermetically sealed against moisture and oil leakage. Cadmium-plated brass can with varnished-paper jacket. Center mounting strap and added connection.

OIL-FILLED TUBULARS—Type —89			
Type 489—400 v. Type 689—600 v.		Type 1089—1000 v. Type 2089 2000 v.	
Cap. Mfd.	Net Price	Net Price	Net Price
.006	\$0.21a	.21a	\$0.24a
.007	.21a	.21a	.24a
.0075	.21a	.21a	.24a
.008	.21a	.21a	.24a
.01	.21a	.21a	.24a
.015	.24a	.24a	.30a
.02	.24a	.24a	.30a
.03	.24b	.30b	.36b
.04	.30b	.36b	.42b
.05	.36b	.42b	.48b
.1	.42b	.48b	.54b
.25	.51e	.57e	.64e
.5	.60f	.67e	.74e

DIMENSIONS			
a	1 3/8 x 1 7/8	u	1 5/8 x 2 1/8
b	4 3/8 x 1 7/8	v	1 1/2 x 2 3/8
c	1 1/2 x 1 1/8	w	1 3/8 x 2 1/8
d	1 1/8 x 2 3/8	x	1 3/8 x 2 3/8

Ask Your Jobber...

Ask him to show you these Type -89 oil-filled midgets. Try them in your very next "rig" or for that servicing job. Ask for new 1941 catalog—or write us direct.



erful 6-tube, 2-band instrument housed in a modern style wood cabinet.

The Radiola 515 provides excellent foreign reception and unusual performance on the standard broadcast band. Its smart appearance is enhanced by the use of matched walnut veneers and horizontal grille rails across the front of the cabinet. The attractive horizontal dial is placed at a 45 degree angle for easy reading.

It has two built-in antennas—one for domestic reception, and the other for foreign tuning. Its many other features include one stage of R-F amplification for greater sensitivity and selectivity, a permanent magnet dynamic loud-speaker, 2-point tone control, automatic volume control, and a plug-in and switch for phonograph attachment.

The Radiola series of instruments was introduced several months ago for distribution by RCA tube and equipment distributors to service dealers. Launched with a minimum of fanfare, the series has nevertheless attained a substantial sales volume throughout the country, with new outlets being added on a steady schedule, Mr. Marden revealed. The Radiola series now includes seven table model radios, a portable radio, and a record player attachment.

Manufacturers' Literature

(Continued from page 40)

facturing Corporation of Bayonne, N. J. The gray-covered circular describes in full detail all the features of the new Model CE Capacitor Examiner. Fifteen features make the Model CE Capacitor Examiner, outstanding among condenser testing apparatus. The other booklet, Bulletin AC, catalogues A. C. Motor Starting Capacitors for replacement purposes, listing them by manufacturer and part number. In addition, an entire page is devoted to instructions on proper usage of the new CAP-CHECK, A. C. Capacitor Checker, which also can be used as an emergency replacement capacitor. Free. (RADIO NEWS No. 2-108.)

NEW TURNER CATALOG. The Turner Co. of Cedar Rapids, Iowa, manufacturers of Microphones for commercial broadcast, public address work, recording and amateur use, are announcing a new Microphone and Microphone Accessory Catalog, which will be distributed free to anyone requesting it.

The Catalog shows and describes such leading numbers in the Turner line as the four new Challenger models, the Han-D Models, the U9-S multi-impedance with impedance selector switch allowing the unit to fill the needs of four microphones, and also such professional stand-bys as the Turner 99 Dynamic.

The complete line of Turner Microphone Accessories is also depicted in this new Catalog. For a free copy, write The Turner Co., 908 17th St. N. E., Cedar Rapids, Iowa. Free.

Technical Review

(Continued from page 40)

Larger than ever before, it contains a complete new line of receivers, recorders, auto radios and replacement parts. The new Lafayette personal radio makes its first appearance within its pages, along with other popular portables which have won popular favor within the past year. An easy-to-read index is included for easy location of any part. Copies are available upon request to the Lafayette Radio Company at their branches, in New York City, Atlanta, Chicago, Boston. —50—

SERVICEMAN'S CASE HISTORIES

Reprinted with permission, from RADIO Trouble Shooters Handbook. Copyright, 1939, Radio & Technical Publishing Co. Copyright in Canada and Great Britain, and all countries subscribing to the Berne Convention, by Radio & Technical Publishing Co. All rights reserved.

GENERAL ELECTRIC (CANADIAN) L6CB
(Uses same chassis as RCA-223 receiver.) See the Case Histories listed for the RCA-223 receiver

GENERAL ELECTRIC (CANADIAN) M-41, M-42
(Uses same chassis as RCA-100 and RCA M-101 receivers.) See the Case Histories listed for the RCA-100 and RCA M-101 receivers

GENERAL ELECTRIC (CANADIAN) M-51, M-52
(Uses same chassis as RCA-118 receiver.) See the Case Histories listed for the RCA-118 receiver

GENERAL ELECTRIC (CANADIAN) M-56
(Uses same chassis as RCA-211 receiver.) See the Case Histories listed for the RCA-211 receiver

GENERAL ELECTRIC (CANADIAN) M-61
(Uses same chassis as RCA-128 receiver.) See the Case Histories listed for the RCA-128 receiver

GENERAL ELECTRIC (CANADIAN) M-62
(Uses same chassis as RCA-121 receiver.) See the Case Histories listed for the RCA-121 receiver

GENERAL ELECTRIC (CANADIAN) M-67
(Uses same chassis as RCA-224 receiver.) See the Case Histories listed for the RCA-224 receiver

GENERAL ELECTRIC (CANADIAN) M-69
(Uses same chassis as RCA-121 receiver.) See the Case Histories listed for the RCA-121 receiver

GENERAL ELECTRIC (CANADIAN) M-81
(Uses same chassis as RCA-143 receiver.) See the Case Histories listed for the RCA-143 receiver

GENERAL ELECTRIC (CANADIAN) M-86
(Uses same chassis as RCA-242 receiver.) See the Case Histories listed for the RCA-242 receiver

GENERAL ELECTRIC (CANADIAN) M-106, M-107
(Uses same chassis as RCA-262 receiver.) See the Case Histories listed for the RCA-262 receiver

GENERAL ELECTRIC (CANADIAN) M-125
(Uses same chassis as RCA-281 receiver.) See the Case Histories listed for the RCA-281 receiver

GENERAL ELECTRIC (CANADIAN) S-22, S-22-X
(Uses same chassis as RCA R-7 receiver.) See the Case Histories listed for the RCA R-7 receiver

GENERAL ELECTRIC (CANADIAN) S-42
(Uses same chassis as RCA R-8 receiver.) See the Case Histories listed for the RCA R-8 receiver

GENERAL ELECTRIC (CANADIAN) S-42-A
(Uses same chassis as RCA R-7A receiver.) See the Case Histories listed for the RCA R-7A receiver

GENERAL ELECTRIC (CANADIAN) S-42-B
(Uses same chassis as RCA R-43 receiver.) See the Case Histories listed for the RCA R-43 receiver

GENERAL ELECTRIC (CANADIAN) T-41
(Uses same chassis as RCA Radiola 48 receiver.) See the Case Histories listed for the RCA Radiola 48 receiver

GENERAL INDUSTRIES Record Changers
Records do1) some records have eccentric grooves that do not permit sufficient lateral reciprocating motion for the pickup arm to operate the trip mechanism. In this case an adjustment of the latch plate (located near the base of the pickup) is necessary. This is done by loosening the screw at the outer end of the plate and turning the eccentric washer in a direction that will bring the ratchet closer to the trip mechanism. This must be carefully set so that the trip lever will operate with a very small lateral movement of the pickup arm

"The More You Learn - The More You Will Earn"

LEARN QUICKLY...ALL YOU NEED...AT LOW COST
IN GHIRARDI'S 3 FAMOUS RADIO BOOKS



ALFRED A. GHIRARDI

"The man who has helped thousands of beginners launch their radio careers and thousands of practicing service men make their careers more successful."

Service Men: You Need Both JOB DATA and THEORY!

Beginners—Here's YOUR EDUCATION in RADIO Fundamentals

NOW—at last—you can get your start in Radio . . . you can prepare for a good-paying radio job, without expensive schooling or lengthy study. Here in one inexpensive volume is a complete Radio Education for you—everything clearly explained, illustrated and easy to understand—right from basic electrical theory up through Television, Cathode-Ray tubes, Aircraft Radio, Public Address, Photoelectric Cells, etc.

The Complete Ghirardi Course in 1 Handy Volume
Radio Physics Course is a miracle of condensation. It's really 36 different instruction courses covering the vast field of Radio all packed into 1 big easy-reading, home training book—everything you need for a complete knowledge of modern Radio Fundamentals!

36 VOLUMES IN 1

1. Radio Broadcasting System. 2. Sound, Speech, Music. 3. Electron Theory; Electric Current. 4. Electrical Units; Ohm's Law; Resistance. 5. Electrical Circuits; Batteries. 6. Magnetism. 7. Electro-magnetism. 8. Electromagnetic Induction. 9. Inductance. 10. Capacitance; Condensers. 11. Alternating Current Circuits. 12. Electric Filters. 13. Measuring Instruments. 14. Radio Waves. 15. Broadcasting. 16. Receiving. 17. Vacuum Tube Principles. 18. Vacuum Tube Characteristics. 19. Vacuum Tube Construction. 20. Vacuum Tube Detector and Amplifier Action. 21. Radio Frequency Amplification. 22. Superhetrodyne Receivers. 23. Radio Frequency Amplifiers; Tuning Coils. 24. Audio Amplifiers. 25. Speakers. 26. Factory Operator Receivers. 27. Power Supply Units. 28. Electric Receivers. 29. Automobile and Aircraft Radio. 30. Phono-Pickups; Public Address Systems. 31. Short-Wave Reception. 32. Photoelectric Cells; Cathode-Ray Tubes. 33. Television. 34. Antennas and Grounds. 35. Testing; Servicing. 36. Sound Motion Pictures. Appendix of Charts and Tables.

YOU LEARN AT HOME Quickly—EASY AS A.B.C.

Sit in your easy chair and let Ghirardi train you for whatever type of radio work you want to do. It's as simple as that! Just spend a few minutes a day of your spare time reading this fascinating book. No previous study or experience necessary—no "math"! You teach yourself—checking your progress with the 856 self-testing Review Questions. Never before has it been possible to master the Basic Fundamentals of Radio so easily, so quickly, so economically.

TELEVISION MADE EASY, TOO!

The Television section is a whole course in itself! And as for Sound Engineering, you get up-to-date instruction in Public Address Systems, Sound Recording, Phono Pickups, Sound Motion Pictures, etc., etc. It's the same with Photoelectric Cells and Cathode-Ray Tubes—each of these specialized sciences is covered in itself. . . . yes, everything you want—all right here! The U. S. Army and Navy use this very same book for their audio training courses. Civil aviation schools and leading radio schools everywhere use it more than any other radio text published. Ghirardi's course is TOPS!

Send for your 5-Day Examination copy TODAY! Rush the coupon to us at once!

**972 PAGES
508 ILLUS**

**GET
STARTED
DO IT NOW!**



**FREE
CIRCULARS!**

RADIO Trouble-Shooter's HANDBOOK

Regardless of what radio set you are called upon to repair, this new "Ghirardi" Handbook is guaranteed to save your Time. Chock full of factory-checked "bench data" that will speed up every service job you do. That means More Money for you!

3,313 CASE HISTORIES to Save Your Servicing Time!

This section alone is worth many times the nominal price of the book. Here at a glance is dependable factory-checked "Case History" repair data on 3,313 different receivers! Compiled from actual service records—with precise instructions on where to look for troubles and how to remedy them. Just think of the time these will save you! But that's not all—see what else you get:

518 BIG 8 1/2x11 PAGES—134 ILLUSTRATIONS, DRAWINGS, CHARTS, TABLES—GIVE VITAL INFORMATION ON:

Time-Saving Trouble Case Histories for 3,313 receivers—I-F Peaks for 15,000 Superhets—Trouble-Shooting Charts—Auto Radio Gear Ratios—Auto Radio Installation, Servicing, Interference Suppression Charts—Servicing Sound Recorders and Intercommunicators—Condenser & Resistor Charts—Grid Bias Resistors—Color Codes—Wire Tables—Coils—Transformers—Formulas—Calculations—Decibel Charts—Tube Charts—Dial Lamps—Ballast Resistors—Filters—Trade Directories—and dozens of other detailed subjects.

The only book of its kind! Contains the greatest mass of practical working service data ever assembled in one book. A servicing gold mine! Used daily by thousands of service shops. Order yours now—Money back if not satisfied.

\$ 3 518 PAGES. 134 Illustrations. Standard Manual Size (8 1/2x11). Fabrikoid-bound.

"MONEY-SAVING COMBINATION PRICE"

1300 PAGES. \$ 4
706 Illustrations.
720 Review Questions. 766 Topics.

BOTH Servicing Books

\$ 6.50

Here's how to get your books:

Radio & Technical Pub. Co., Dept. RN-31, 45 Astor Place, New York, N. Y.

- Gentlemen, Enclosed find payment for and rush to me postpaid for Examination, with your 5-Day Money-Back Guarantee:
- MODERN RADIO SERVICING at \$4. RADIO TROUBLE-SHOOTER'S HANDBOOK at \$3. (foreign \$3.50)
 - BOTH SERVICING BOOKS at \$6.50 Special Money-Saving Combination Price (foreign \$7)
 - RADIO PHYSICS COURSE at \$4. (foreign \$4.50)

NAME _____
ADDRESS _____
CITY _____ STATE _____

Please send me FREE descriptive illustrated literature.
TEAR OFF THIS COUPON, MAIL IT IN AN ENVELOPE, OR PASTE IT ON A POSTCARD!

MODERN Radio SERVICING

This big servicing book gives you a complete, concise, self-instruction course in present-day radio servicing test instruments and latest servicing methods as practiced by leading servicing organizations throughout the country. A complete course in basic servicing theory, together with the practical applications—essential knowledge for trouble-shooting and repairing all complicated receivers of today. The only book in the world that teaches you everything you need to know—right in your own home—easily, in your spare time, and inexpensively!

LEARN SERVICING This Way!

- Test Equipment—First, a thorough 420-page course in Test Instruments—Theory, Descriptions, Diagrams of all Commercial Instruments. How They Work. Construction Data, etc.
- Trouble-Shooting—Next, all newest short-cut factory methods for Trouble-shooting and Testing all makes of radio sets (and electronic equipment)—explained clearly and step-by-step.
- Repairing—Then how to Align and Adjust receivers; how to Repair or Replace faulty parts. "Factory" methods explained fully.
- Business Promotion—Finally, how to Manage, Promote and Advertise a radio service shop for greatest profits.

MODERN RADIO SERVICING brings you an illustrated treasure chest of servicing knowledge—all based on practical servicing experience! 720 Self-Examination Review Questions check every step of your study. Order yours now—costs you only \$4 to learn radio service work this EASY way! Money back if not satisfied!

Use Them
5 DAYS
—OUR RISK
Money-Back Guarantee!

Sensation OF THE INDUSTRY!..



and, so far, we've hardly even mentioned its **GREATER METER PROTECTION!**

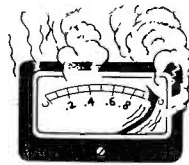

Is this your D-C Voltmeter?

Not only is the RCA Junior Volt-Ohmyst one of the handiest, most versatile and amazingly efficient instruments on the market today... Not only does it pave the way for faster, more accurate resistance and both a-c and d-c voltage readings... Equally important, special protective features remove much of the danger of a costly meter burnout should you grab hold of more voltage than you had expected or accidentally check a "hot" resistor. Extremely rugged meter construction also guards against mechanical damage. This means that, besides giving you more for your money in the first place, this sensational little instrument *protects your investment*. What's more, the Junior VoltOhmyst will quickly pay for itself in the time it saves on a wide variety of jobs.

A LONG-TIME INVESTMENT IN BETTER, FASTER WORK

The RCA Junior VoltOhmyst is a "junior" in price alone. In actual use it is an instrument that does a man's-size job *plus*. Costing only a little more than you'd pay for an ordinary volt-ohmmeter, it gives you Electronic Push-Pull operation with all the time- and trouble-saving features of the famous Rider VoltOhmyst circuits and with the addition of an isolated A-C Rectifier-type Voltmeter with 1000 ohms per volt sensitivity.

It measures d-c voltages with constant meter impedance of 11,000,000 ohms on all ranges. *This means a sensitivity up to 3,666,666 ohms per volt!* Yet it is extremely stable! It will not disrupt operation of sensitive circuits.

It has six full scale voltage ranges from 3 to 1000 volts and measures resistances from 0.1 to 1,000,000,000 ohms! It eliminates time-taking shorting of leads and zero re-settings when changing ohmmeter scales. One wide-spread ohms scale assures extreme accuracy and easy readability. In brief, the RCA Junior VoltOhmyst provides you with a quick, accurate and easy-to-use means of checking every conceivable A.V.C., A.F.C., FM discriminator circuit, or Oscillator Grid Voltage, *with the signal present*, checking bias cells or insulation resistance, obtaining practically any needed resistance and d-c voltage reading... as well as handling any a-c voltage checking job that might pop up in your work—at an absolute minimum price.

See it at your nearest RCA distributors—or write for bulletin. It is an instrument that no wide-awake technician can afford to miss! Sooner or later, why not now?

RCA Junior
VOLT OHMYST

\$34.95

Net Price Complete. Stock No. 165

SOMETHING TO REMEMBER WHEN YOU BUY TEST EQUIPMENT

Although moderately priced, RCA Test Equipment is not built down "to a price." Instead, it is built up to a standard of efficiency—the highest in the field today. It is designed in the firm belief that the "cheapest" equipment any service technician can buy is the equipment which is quickest to pay for itself in the time it saves him, plus the extra jobs it permits him to handle. Moreover, RCA Test Equipment is built around the famous and pioneer Rider "Signal Tracing" system which replaces old-style, hit-or-miss service methods with a quick, systematic course of procedure. "Signal Tracing" has proved its tremendous value, not only to leading technicians, but to leading laboratories and manufacturing plants as well. It is your safest, surest road to faster, more accurate work with consequent greater profits—and the RCA-Rider Chanalyst, that originally made this system possible, is your "Open Sesame!" to its many benefits.

Not what you pay for your Test Equipment—but *what your Test Equipment pays you*. That's what really counts. And RCA's policy of "Minimized Obsolescence" protects your investment!



Test Equipment

YOUR KEY TO SYSTEMATIC
SERVICING FOR GREATER PROFIT

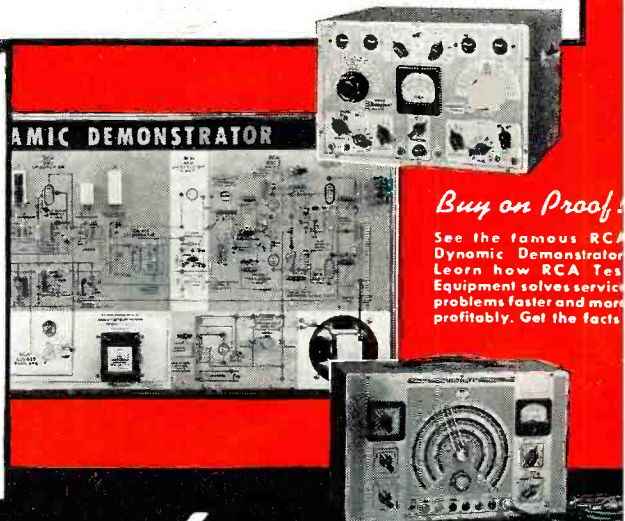

Buy on Proof!

See the famous RCA Dynamic Demonstrator. Learn how RCA Test Equipment solves service problems faster and more profitably. Get the facts.

RCA MANUFACTURING CO., INC., CAMDEN, N. J. • A Service of The Radio Corporation of America. In Canada: RCA Victor Company Limited, Montreal